

NUC-TGU

1th Gen Intel® Tiger Lake UP3 Fanless NUC Slim System

Quick Reference Guide

3rd Ed – 12 December 2022

Copyright Notice

Copyright © 2022 ALL RIGHTS RESERVED.

FCC Statement



THIS DEVICE COMPLIES WITH PART 15 FCC RULES. OPERATION IS SUBJECT TO THE FOLLOWING TWO CONDITIONS:

(1) THIS DEVICE MAY NOT CAUSE HARMFUL INTERFERENCE.

(2) THIS DEVICE MUST ACCEPT ANY INTERFERENCE RECEIVED INCLUDING INTERFERENCE THAT MAY CAUSE UNDESIRE OPERATION.

THIS EQUIPMENT HAS BEEN TESTED AND FOUND TO COMPLY WITH THE LIMITS FOR A CLASS "A" DIGITAL DEVICE, PURSUANT TO PART 15 OF THE FCC RULES.

THESE LIMITS ARE DESIGNED TO PROVIDE REASONABLE PROTECTION AGAINST HARMFUL INTERFERENCE WHEN THE EQUIPMENT IS OPERATED IN A COMMERCIAL ENVIRONMENT. THIS EQUIPMENT GENERATES, USES, AND CAN RADIATE RADIO FREQUENCY ENERGY AND, IF NOT INSTALLED AND USED IN ACCORDANCE WITH THE INSTRUCTION MANUAL, MAY CAUSE HARMFUL INTERFERENCE TO RADIO COMMUNICATIONS.

OPERATION OF THIS EQUIPMENT IN A RESIDENTIAL AREA IS LIKELY TO CAUSE HARMFUL INTERFERENCE IN WHICH CASE THE USER WILL BE REQUIRED TO CORRECT THE INTERFERENCE AT HIS OWN EXPENSE.

A Message to the Customer

Customer Services

Each and every product is built to the most exacting specifications to ensure reliable performance in the harsh and demanding conditions typical of industrial environments. Whether your new device is destined for the laboratory or the factory floor, you can be assured that your product will provide the reliability and ease of operation.

Your satisfaction is our primary concern. Here is a guide to our customer services. To ensure you get the full benefit of our services, please follow the instructions below carefully.

Technical Support

We want you to get the maximum performance from your products. So if you run into technical difficulties, we are here to help. For the most frequently asked questions, you can easily find answers in your product documentation. These answers are normally a lot more detailed than the ones we can give over the phone. So please consult the user's manual first.

Content

1. Getting Started	6
1.1 Safety Precautions	6
1.2 Packing List	6
1.3 System Specifications	7
1.4 System Overview.....	11
1.4.1 Front View	11
1.4.2 Rear View.....	11
1.5 System Dimensions.....	12
2. Hardware Configuration	13
2.1 NUC-TGU connector mapping.....	14
2.1.1 Serial Port 1/2 connector (COM1/2)	14
2.2 NCM-TGU Overviews	15
2.3 NCM-TGU Jumper & Connector list	16
2.4 NCM-TGU Jumpers & Connectors settings.....	17
2.4.1 Serial port 1/2 pin9 signal select (JRI1/2)	17
2.4.2 Clear CMOS (JRTC1)	17
2.4.3 AT/ATX Input power select (JAT1)	18
2.4.4 ESPI connector (JESPI1).....	18
2.4.5 EC Debug connector (JECROM1).....	19
2.4.6 Battery connector (JBAT1).....	19
2.4.7 Front Panel connector (JFP1).....	20
2.4.8 USB connector (JUSB1)	20
2.4.9 Audio connector (JLIN1)	21
2.4.10 BIOS EC connector (JBIOS_EC1)	21
2.4.11 Power connector (DCIN2)	22
2.4.12 General purpose I/O connector (JDIO1)	22
2.5 Installing Din Rail Mounting (NUC-TGU)	23
2.6 Installing Stand Mounting (NUC-TGU)	24
2.7 Installing VESA Mounting (NUC-TGU)	25
2.8 Installing Memory & M.2 card (NUC-TGU)	26
3. BIOS Setup	28
3.1 Introduction.....	29
3.2 Starting Setup.....	29
3.3 Using Setup	30
3.4 Getting Help.....	31

NUC-TGU

3.5	In Case of Problems	31
3.6	BIOS setup	32
3.6.1	Main Menu	32
3.6.1.1	System Language.....	33
3.6.1.2	System Date	33
3.6.1.3	System Time.....	33
3.6.2	Advanced Menu	33
3.6.2.1	Connectivity Configuration.....	34
3.6.2.2	CPU Configuration.....	34
3.6.2.3	Power & Performance	35
3.6.2.3.1	CPU – Power Management Control	36
3.6.2.4	PCH-FW Configuration.....	37
3.6.2.4.1	Firmware Update Configuration.....	37
3.6.2.5	Trusted Computing	38
3.6.2.6	APCI Settings	38
3.6.2.7	Super IO Configuration.....	39
3.6.2.7.1	Serial Port 1 Configuration	40
3.6.2.7.2	Serial Port 2 Configuration	41
3.6.2.8	HW Monitor	42
3.6.2.9	S5 RTC Wake Settings.....	42
3.6.2.10	USB Configuration	43
3.6.2.11	Network Stack Configuration	44
3.6.2.12	NVMe Configuration	44
3.6.3	Chipset	45
3.6.3.1	System Agent (SA) Configuration.....	45
3.6.3.1.1	Memory Configuration	46
3.6.3.1.2	Graphics Configuration.....	46
3.6.3.1.3	VMD setup menu	47
3.6.3.2	PCH-IO Configuration.....	47
3.6.3.2.1	PCI Express Configuration	48
3.6.3.2.1.1	PCI Express Root Port 6(M.2 KeyE).....	48
3.6.3.2.1.2	PCI Express Root Port 8(LAN2-I225)	49
3.6.3.2.1.3	PCI Express Root Port 11(M.2 KeyB).....	50
3.6.3.2.2	SATA And RST Configuration	51
3.6.3.2.3	HD Audio Configuration.....	51
3.6.3.3	Board & Panel Configuration	52
3.6.3.3.1	SHOW DMI INFO	53
3.6.4	Security	53
3.6.4.1	Secure Boot	54
3.6.4.1.1	Key Management.....	55

4 NUC-TGU Quick Reference Guide

3.6.5	Boot.....	55
3.6.6	Save and exit	56
3.6.6.1	Save Changes and Reset.....	57
3.6.6.2	Discard Changes and Reset.....	57
3.6.6.3	Restore Defaults	57
3.6.6.4	Launch EFI Shell from filesystem device	57
4.	Drivers Installation.....	58
4.1	Install Chipset Driver	59
4.2	Install VGA Driver	60
4.3	Install LAN Driver.....	61
4.4	Install Serial IO Driver.....	62
4.5	Install Audio Driver	63
4.6	Install ME Driver	64
4.7	Install Realtek Audio Control Driver.....	65

1. Getting Started

1.1 Safety Precautions

Warning!



Always completely disconnect the power cord from your chassis whenever you work with the hardware. Do not make connections while the power is on. Sensitive electronic components can be damaged by sudden power surges. Only experienced electronics personnel should open the PC chassis.

Caution!



Always ground yourself to remove any static charge before touching the CPU card. Modern electronic devices are very sensitive to static electric charges. As a safety precaution, use a grounding wrist strap at all times. Place all electronic components in a static-dissipative surface or static-shielded bag when they are not in the chassis.

1.2 Packing List

- 1 x NUC-TGU Intel® Core® SoC Processor Fanless System
- 1 x AC to DC Adapter
- 1 x Table Stand
- 1 x Din Rail
- 1 x VESA
- 4 x Rubber Foot
- 1 x Screw Kit
- 1 x M.2 2252 to 2242 Bracket



If any of the above items is damaged or missing, contact your retailer.

1.3 System Specifications

System	
Processor	Intel® Core™ i7-1165G7 Processor Intel® Core™ i5-1135G7 Processor Intel® Core™ i3-1115G4 Processor Intel® Core™ i7-1185G7E Processor Intel® Core™ i5-1145G7E Processor Intel® Core™ i3-1115G4E Processor Intel® Celeron® 6305E Processor
System Memory	1 x 260-Pin SO-DIMM Socket, Max. Up to 32GB DDR4 3200MHz
I/O Chipset	Tiger Lake SoC integrated
ESPI to LPC	EC ITE IT5571VG-I-128/CX
BIOS Information	AMI uEFI BIOS, 256Mbit SPI Flash ROM
Watchdog Timer	H/W Reset, 1sec. ~ 65535sec.
H/W Status Monitor	Monitoring System Temperature and Voltage with Auto Throttling Control
TPM	TPM 2.0 (NuvoTon NPCT754AADYX co-lay with Infineon SLB9670VQ2.0)
iAMT	Only available on i7 and i5 the Embedded Options Available CPU.
SBC	NCM-TGU
Expansion	
M.2 (Key-X, Size, Signal)	1 x M.2 Key-M 2280 (PCIe Gen4 x 4) 1 x M.2 Key-B 2242/3042/3052 with Internal SIM Slot (PCIe, SATA, USB 2.0) 1 x M.2 Key-E 2230 (PCIe, USB 2.0)
Storage	
M.2 (Key-X, Size, Signal)	1 x M.2 Key-M 2280 NVMe (PCIe Gen4 x 4) 1 x M.2 Key-B 2242 (PCIe Gen4 x1, SATA3)
Edge I/O (Front)	
USB Port	2 x USB 2.0
Audio	1 x Line-Out, 1 x Mic-In
COM Port	2 x RS232/422/485 (BIOS)
Power Button	1 x Power On/Off w/ LED
LED Indicator	1 x Data Access 1 x Wi-Fi 1 x LTE
Edge I/O (Rear)	
USB Port	4 x USB 3.2 Gen2
HDMI	2 x HDMI 2.0b
RJ-45	2 x RJ45d
DC Jack	1 x Lockable DC Jack

NUC-TGU

Kensington Lock	1 x Kensington Lock																																										
Edge I/O (Right)																																											
Antenna	2 x Antenna Mounting with Dust Protection Cover																																										
Edge I/O (Left)																																											
Antenna	2 x Antenna Mounting with Dust Protection Cover																																										
Display																																											
Graphic Chipset	Intel® Iris® Xe Graphics (i7-1165G7/ i7-1185G7E/i5-1135G7/ i5-1145G7E) Intel® UHD Graphics for 11th Gen Intel® Processors (i3-1115G4/ i3-1115G4E/ Celeron 6305E)																																										
Resolution	2 x HDMI 2.0b: 4096x2304@60Hz																																										
Audio																																											
Audio Codec	RealTek ALC888S-VD2-GR (Co-Layout RealTek ALC897-VA2-CG)																																										
Ethernet																																											
LAN Chipset	Intel® Ethernet Controller I225-LM Intel® Ethernet Controller I219-LM																																										
Specification	10/100/1000/2.5 Gigabit (I225-LM) 10/100/1000 Gigabit (I219-LM)																																										
LED Indicator	<p>Max. 1G LAN Port</p> <table border="1"> <thead> <tr> <th colspan="2">ACT/LINK</th> <th colspan="2">SPEED</th> </tr> <tr> <th>LED</th> <th>Definition</th> <th>LED</th> <th>Definition</th> </tr> </thead> <tbody> <tr> <td>Light Off</td> <td>No Link</td> <td>Solid Orange</td> <td>1G</td> </tr> <tr> <td>Solid Yellow</td> <td>Connection</td> <td>Solid Green</td> <td>100M</td> </tr> <tr> <td>Flashing</td> <td>Activity</td> <td>Light Off</td> <td>10M</td> </tr> </tbody> </table> <p>Max. 1G LAN Port</p> <table border="1"> <thead> <tr> <th colspan="2">ACT/LINK</th> <th colspan="2">SPEED</th> </tr> <tr> <th>LED</th> <th>Definition</th> <th>LED</th> <th>Definition</th> </tr> </thead> <tbody> <tr> <td>Light Off</td> <td>No Link</td> <td>Solid Orange</td> <td>2.5G</td> </tr> <tr> <td>Solid Yellow</td> <td>Connection</td> <td>Solid Green</td> <td>1G/100M</td> </tr> <tr> <td>Yellow Flashing</td> <td>Activity</td> <td>Light Off</td> <td>10M</td> </tr> </tbody> </table>			ACT/LINK		SPEED		LED	Definition	LED	Definition	Light Off	No Link	Solid Orange	1G	Solid Yellow	Connection	Solid Green	100M	Flashing	Activity	Light Off	10M	ACT/LINK		SPEED		LED	Definition	LED	Definition	Light Off	No Link	Solid Orange	2.5G	Solid Yellow	Connection	Solid Green	1G/100M	Yellow Flashing	Activity	Light Off	10M
ACT/LINK		SPEED																																									
LED	Definition	LED	Definition																																								
Light Off	No Link	Solid Orange	1G																																								
Solid Yellow	Connection	Solid Green	100M																																								
Flashing	Activity	Light Off	10M																																								
ACT/LINK		SPEED																																									
LED	Definition	LED	Definition																																								
Light Off	No Link	Solid Orange	2.5G																																								
Solid Yellow	Connection	Solid Green	1G/100M																																								
Yellow Flashing	Activity	Light Off	10M																																								
Power Requirement																																											
DC Input	+12Vdc																																										
DC Input Connector	Lockable DC Jack																																										
ACPI	Single power ATX Support S0, S3, S4, S5 ACPI 5.0 Compliant																																										
Power Mode	AT/ATX (ATX is default setting)																																										
Adapter	AC to DC Adapter																																										
Mechanical & Environment																																											
Operating Temp.	With extended temperature peripherals: 0°C ~ 50°C (32°F ~ 122°F) with 0.5m/s air																																										

	flow
Storage Temp.	-20°C ~ 60°C (-4°F ~ 140°F)
Operating Humidity	40°C @ 95% Relative Humidity, Non-condensing
Dimension (W*L*H)	170mm x 125mm x 36mm(6.69" x 4.92" x 1.42")
Weight	0.97KG (2.14lbs)
Vibration Test	<p>Random Vibration Operation</p> <p>1 Test PSD : 0.00454G²/Hz , 1.5 Grms</p> <p>2 System condition : operation mode</p> <p>3 Test frequency : 5~500 Hz</p> <p>4 Test axis : X,Y and Z axis</p> <p>5 Test time : 30 minutes per each axis</p> <p>6 IEC60068-2-64 Test Fh</p> <p>7 Storage : SSD</p> <p>Sine Vibration test (Non-operation)</p> <p>1 Test Acceleration : 2G</p> <p>2 Test frequency : 5~500 Hz</p> <p>3 Sweep : 1 Oct/ per one minute. (logarithmic)</p> <p>4 Test Axis : X,Y and Z axis</p> <p>5 Test time :30 min. each axis</p> <p>6 System condition : Non-Operating mode</p> <p>7. Reference IEC 60068-2-6 Testing procedures</p> <p>Package Vibration Test:</p> <p>1 Test PSD : 0.026G²/Hz , 2.16 Grms</p> <p>2 Test frequency : 5~500 Hz</p> <p>3 Test axis : X,Y and Z axis</p> <p>4 Test time : 30 minutes per each axis</p> <p>5 IEC 60068-2-64 Test Fh</p>
Shock Test	<p>1 Wave form : Half Sine wave</p> <p>2 Acceleration Rate : 55G</p> <p>3 Duration Time : 11ms</p> <p>4 No. of shock : 3 times</p> <p>5 Test Axis : +/- X, +/-Y, +/-Z axis</p> <p>6 operation mode</p> <p>7 Reference IEC 60068-2-27 testing procedures</p> <p>Test Eb : SSD Shock Test</p>
Drop Test	<p>Package drop test</p> <p>Reference ISTA 2A, Method : IEC-60068-2-32 Test:Ed</p> <p>Test Ea : Drop Test</p>

NUC-TGU

	1 Test phase : One corner, three edges, six faces 2 Test high : 96.5cm 3 Package weight : 5Kg 4 Test drawing
IP Rating	IP40
Mounting Kit	Table Stand/Din Rail/VESA
Software Support	
OS Information	Win10, Win11, Linux
Certification	
Certification Information	CE, FCC Class B
In-Box Accessory	
Accessory	1 x AC to DC Adapter 1 x Table Stand 1 x Din Rail 1 x VESA 4 x Rubber Foot 1 x A bag of gadgets (packs screws, rubber foots)



Note: Specifications are subject to change without notice.

1.4 System Overview

1.4.1 Front View

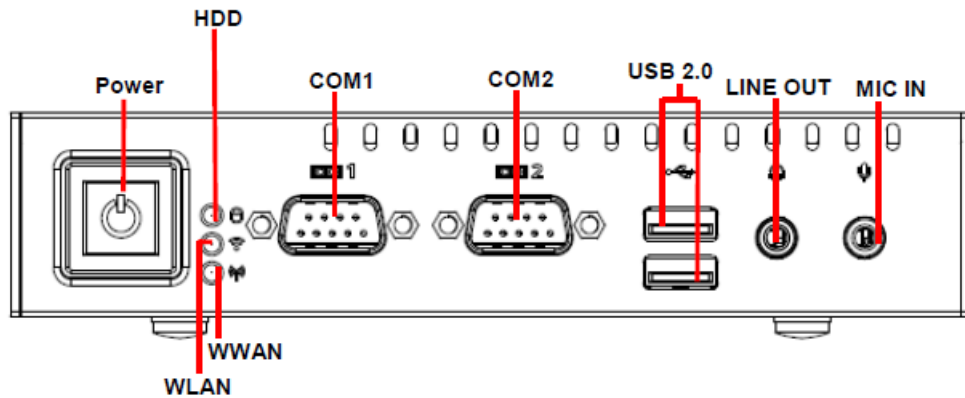

1.4.2 Rear View

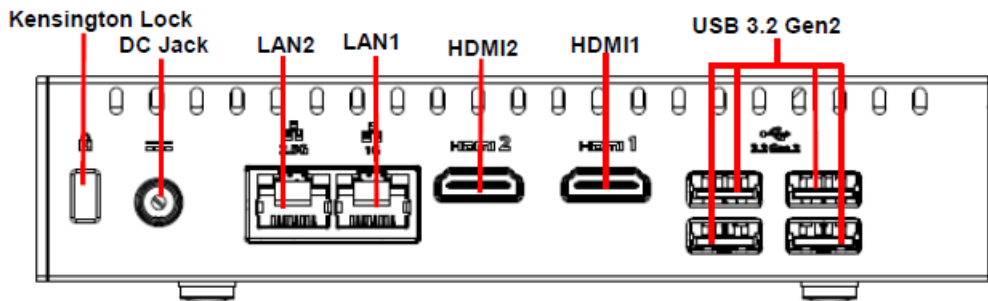

Connectors

Label	Function	Note
Power	Power on button	
USB 2.0	2 x USB2.0 connector	
COM1/2	Serial port 1/2 connector	
WWAN	WWAN Indicator <i>*Note 1</i>	
WLAN	WLAN Indicator <i>*Note 1</i>	
HDD	HDD Indicator <i>*Note 1</i>	
LINE OUT	Line-out audio jack	
MIC IN	Mic-in audio jack	
LAN1/2	RJ-45 Ethernet 1/2	
USB 3.2 Gen2	4 x USB 3.2 Gen2 connector	
DC Jack	Lockable DC Jack <i>*Note 2</i>	
HDMI1/2	2 x HDMI connector	
Kensington Lock	Kensington Lock	

**Note 1:* Please note LED Indicator is based on the design of the card/module.

**Note 2:* Do not unplug the adapter and Jack arbitrarily after booting. It will cause system abnormalities.

1.5 System Dimensions

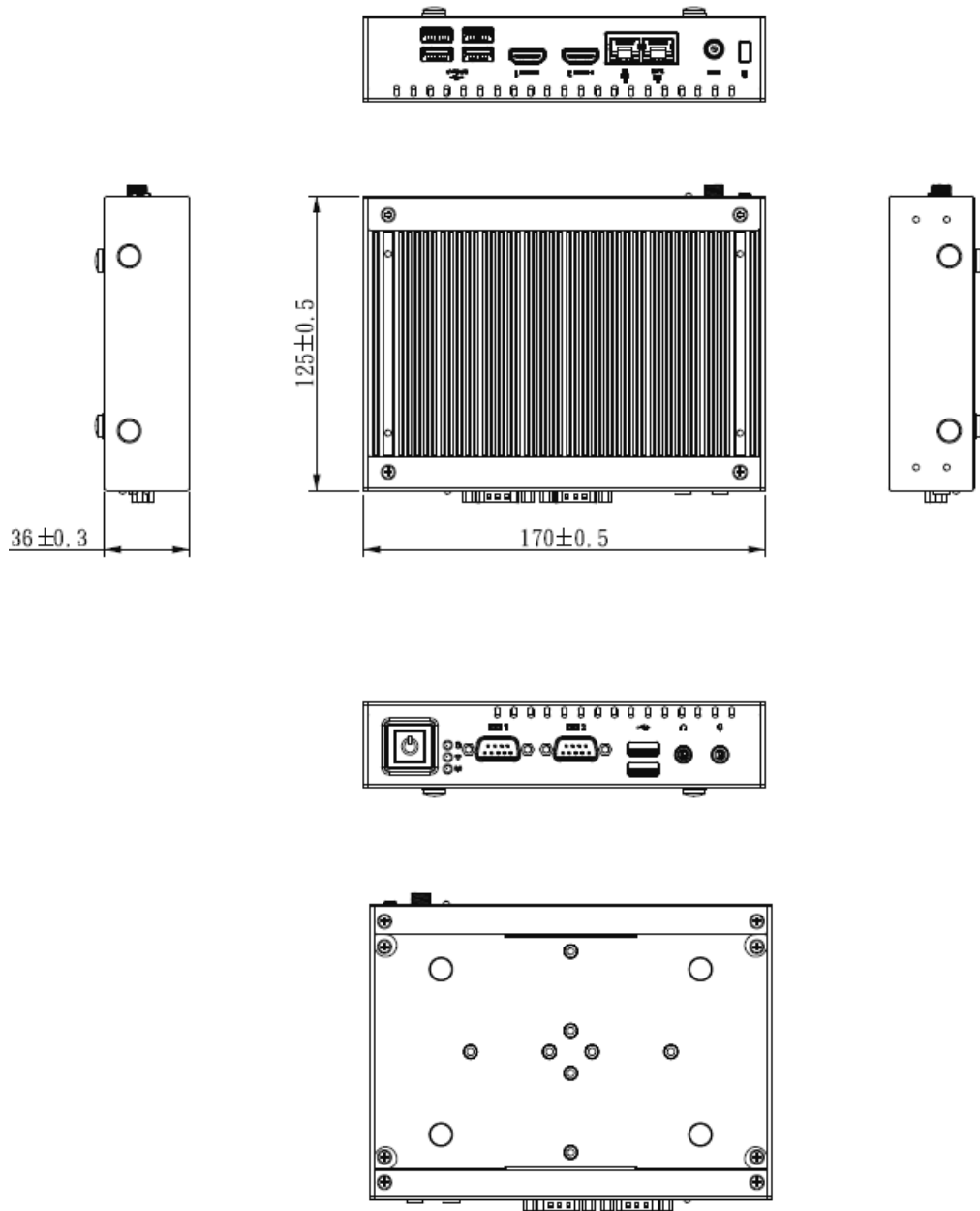

(Unit: mm)

2. Hardware Configuration

Jumper and Connector Setting, Driver and BIOS Installing

For advanced information, please refer to:

- 1- NCM-TGU included in this manual.

2.1 NUC-TGU connector mapping

2.1.1 Serial Port 1/2 connector (COM1/2)

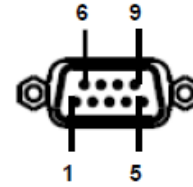
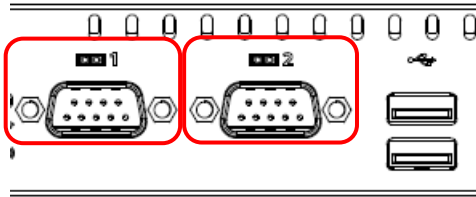

In RS-232 Mode

Signal	PIN	PIN	Signal
NDCD#	1	6	NDSR#
NRXD	2	7	NRTS#
NTXD	3	8	NCTS#
NDTR#	4	9	NRI#
GND	5		

In RS-422 Mode

Signal	PIN	PIN	Signal
TxD1-	1	6	NC
TxD1+	2	7	NC
RxD1+	3	8	NC
RxD1-	4	9	NC
GND	5		

In RS-485 Mode

Signal	PIN	PIN	Signal
DATA1-	1	6	NC
DATA1+	2	7	NC
NC	3	8	NC
NC	4	9	NC
GND	5		

2.2 NCM-TGU Overviews

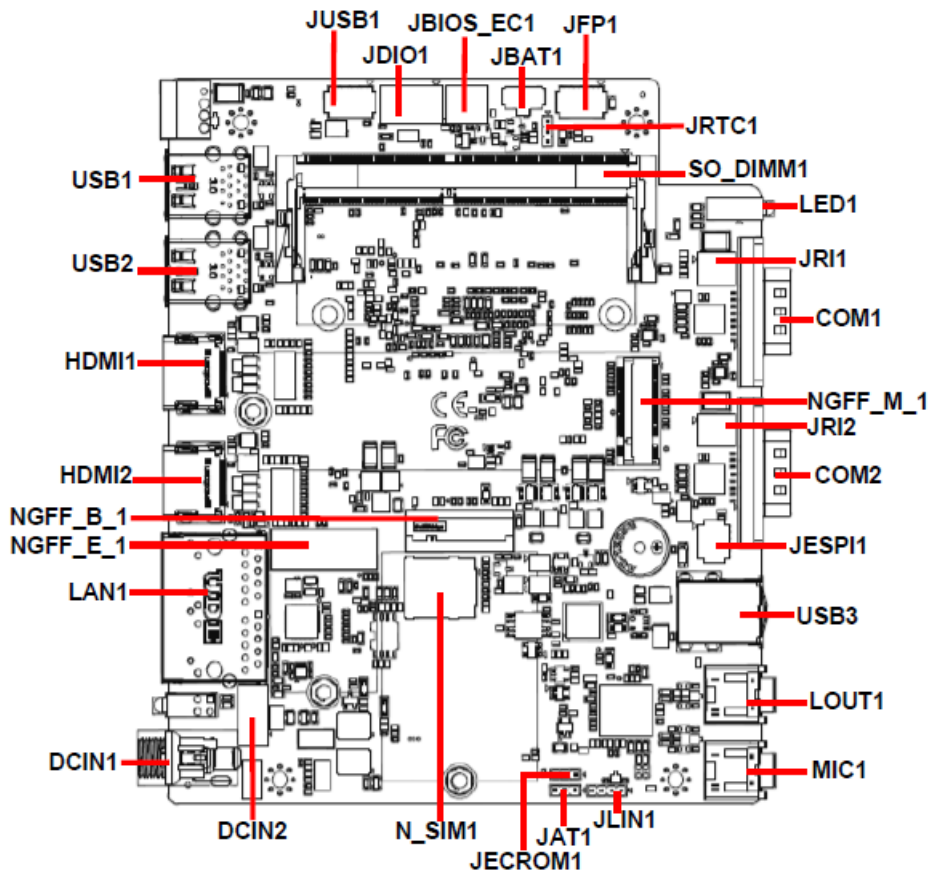

2.3 NCM-TGU Jumper & Connector list

Jumpers

Label	Function	Note
JRI1/2	Serial port 1/2 pin9 signal select	3 x 2 header, pitch 2.00mm
JAT1	AT/ATX Input power select	3 x 1 header, pitch 2.00mm
JRTC1	Clear CMOS	3 x 1 header, pitch 2.00mm

Connectors

Label	Function	Note
COM1	Serial Port 1 connector	
COM2	Serial Port 2 connector	
JDIO1	General purpose I/O connector	6 x 2 wafer, pitch 2.00mm
NGFF_M_1	M.2 KEY-M 2280 connector	
NGFF_E_1	M.2 KEY-E 2230 connector	
NGFF_B_1	M.2 KEY-B 3042/2242/3052 connector	
LED1	HDD/Power LED indicator	
JFP1	Front Panel connector	5 x 2 header, pitch 2.00mm
USB1/2	4 x USB3.2 Gen2 connector	
USB3	2 x USB2.0 connector	
JUSB1	USB2.0 connector	5 x 2 header, pitch 2.00mm
LAN1	RJ-45 Ethernet 1/2	
JBAT1	Battery connector	2 x 1 wafer, pitch 1.25mm
JBIOS_EC1	BIOS EC connector	4 x 2 header, pitch 2.00mm
DCIN1	Power connector	
DCIN2	Power connector	4 x 1 wafer, pitch 2.50mm
JLIN1	Audio connector	4 x 2 header, pitch 2.00mm
SO_DIMM1	DDR4 SODIMM socket	
MIC1	Mic-in audio jack	
LOUT1	Line-out audio jack	
HDMI1/2	HDMI connector 1/2	
N_SIM1	SIM card slot	
JESPI1	ESPI connector	6 x 2 header, pitch 1.27mm
JECROM1	EC Debug connector	3 x 1 header, pitch 2.00mm

2.4 NCM-TGU Jumpers & Connectors settings

2.4.1 Serial port 1/2 pin9 signal select (JRI1/2)

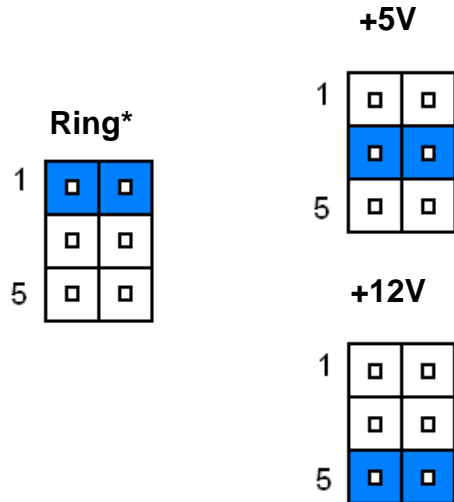
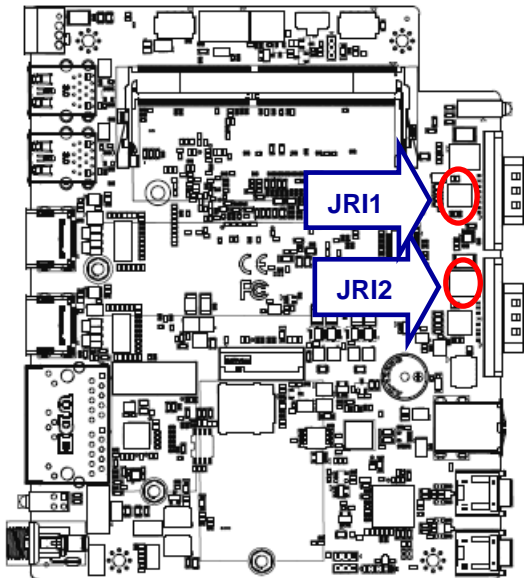

* Default

2.4.2 Clear CMOS (JRTC1)

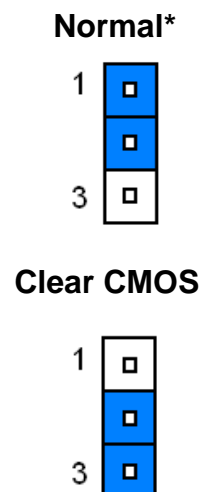
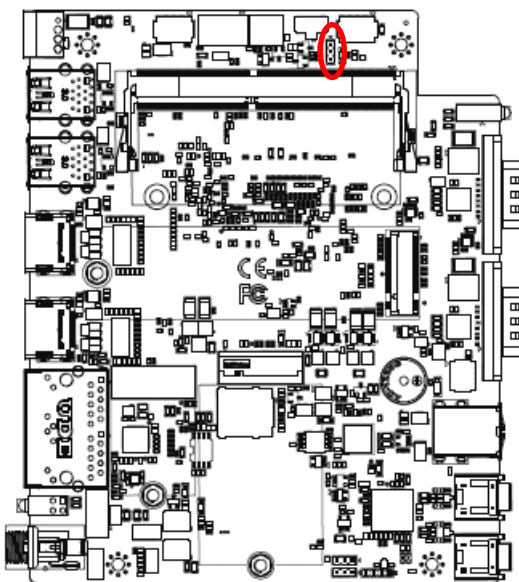

* Default

NUC-TGU

2.4.3 AT/ATX Input power select (JAT1)

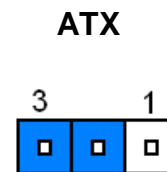
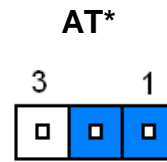
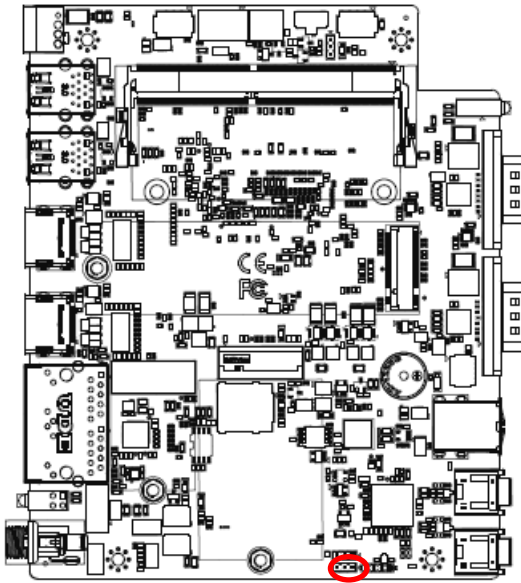

* Default

2.4.4 ESPI connector (JESPI1)

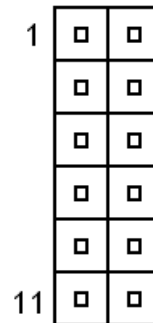
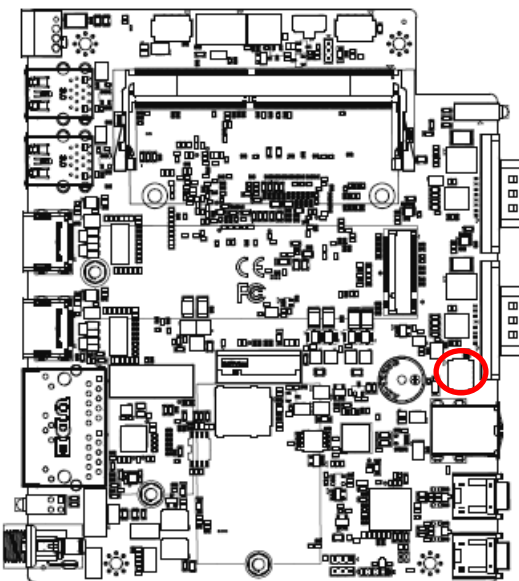

Signal	PIN	PIN	Signal
eSPI_R_IO0	1	2	+3.3V
eSPI_R_IO1	3	4	RST_TPM#
eSPI_R_IO2	5	6	eSPI_R_CS#
eSPI_R_IO3	7	8	eSPI_R_CLK
NC	9	10	GND
eSPI_R_RST#	11	12	NC

2.4.5 EC Debug connector (JECROM1)

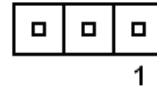
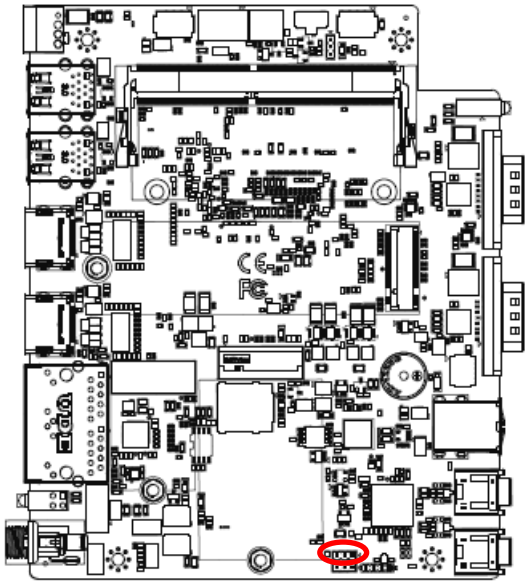

Signal	PIN
EC_SMCLK_DEBUG	1
EC_SMDAT_DEBUG	2
GND	3

2.4.6 Battery connector (JBAT1)

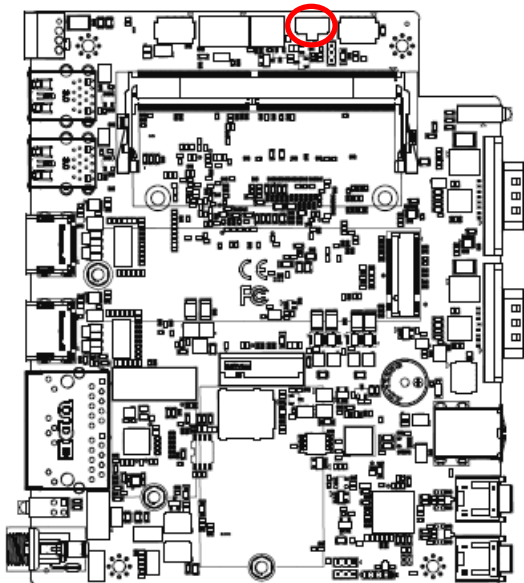

Signal	PIN
+RTCBATT	1
GND	2

NUC-TGU

2.4.7 Front Panel connector (JFP1)

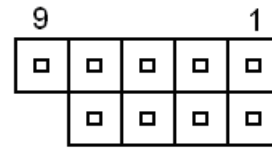
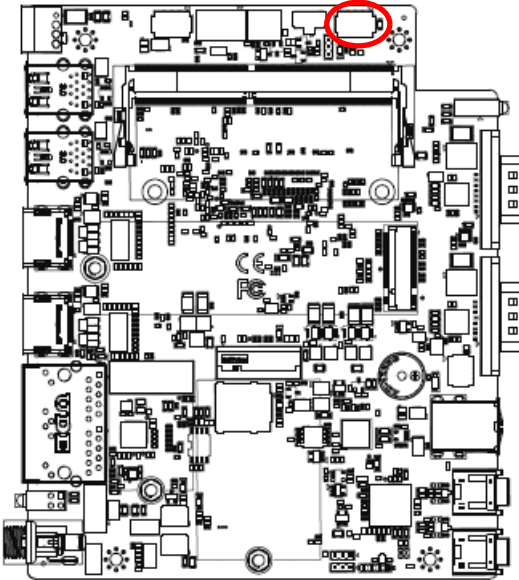

Signal	PIN	PIN	Signal
HDD_LED_P	1	2	PWR_LED_P
HDD_LED#	3	4	PWR_LED#
PM_SYSRST#	5	6	PWRBTN_IN#
GND	7	8	GND
NC	9		

2.4.8 USB connector (JUSB1)

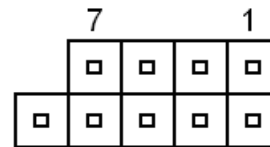
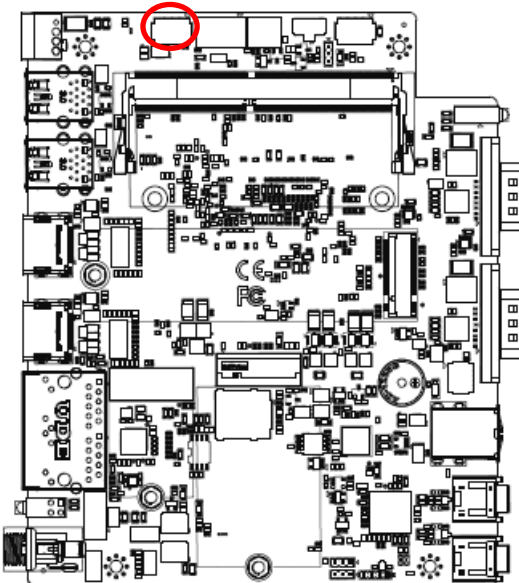

Signal	PIN	PIN	Signal
+5VSB	1	2	+5VSB
USB_R_DN7	3	4	USB_R_DN8
USB_R_DP7	5	6	USB_R_DP8
GND	7	8	GND
		10	GND

2.4.9 Audio connector (JLIN1)

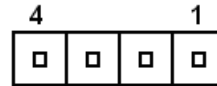
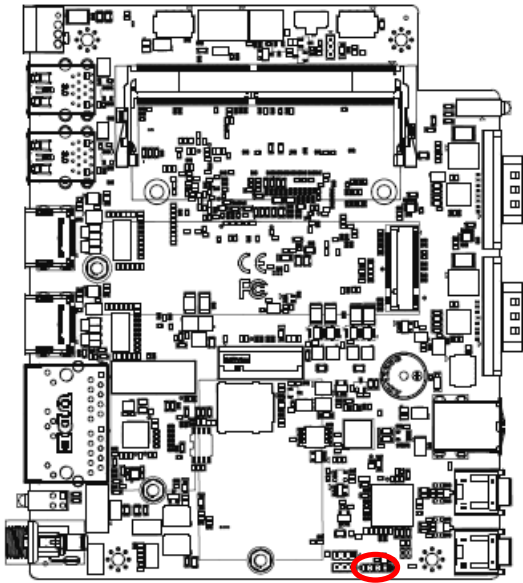

Signal	PIN
LINE1-R-IN	1
LINE1-L-IN	2
HD_AGND	3
LINE1-JD	4

2.4.10 BIOS EC connector (JBIOS_EC1)

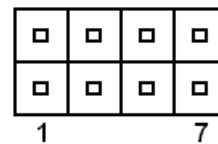
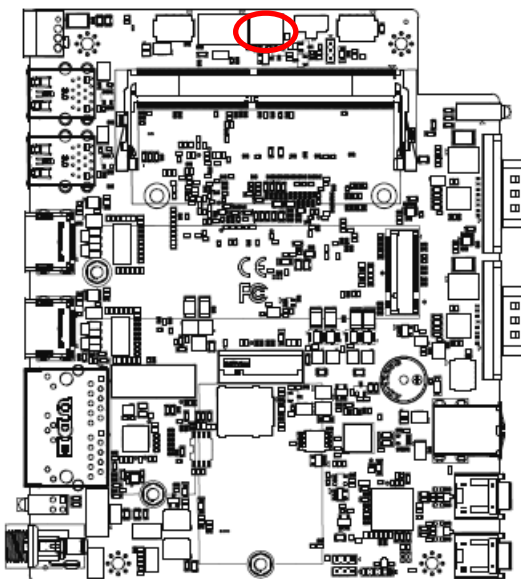

Signal	PIN	PIN	Signal
+3.3VSB	1	2	GND
SPI_CS0#_ROM	3	4	SPI_CLK_ROM
SPI_MISO_ROM	5	6	SPI_MOSI_ROM
SPI_HOLD#_ROM	7	8	SPI_WP#_ROM

NUC-TGU

2.4.11 Power connector (DCIN2)

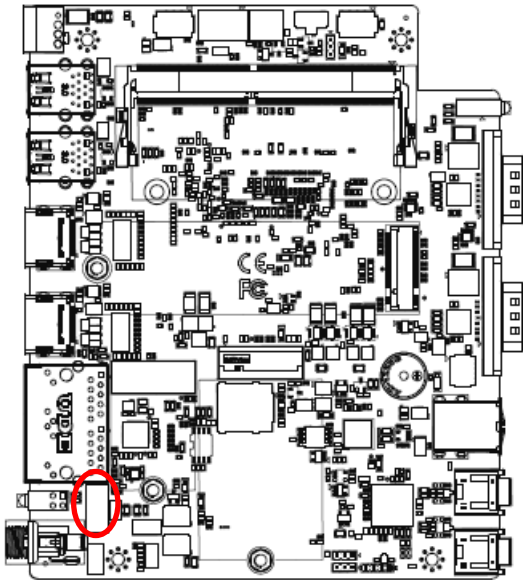

Signal	PIN
GND	4
GND	3
+12VSB	2
+12VSB	1

2.4.12 General purpose I/O connector (JDIO1)

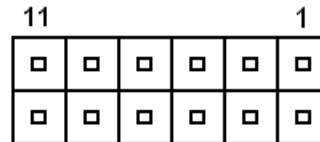
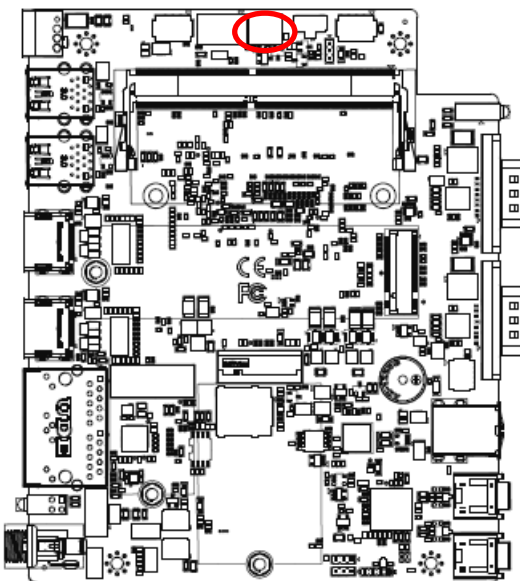

Signal	PIN	PIN	Signal
DIO_GP20	1	2	DIO_GP10
DIO_GP21	3	4	DIO_GP11
DIO_GP22	5	6	DIO_GP12
DIO_GP23	7	8	DIO_GP13
SMB_SCL_S0	9	10	SMB_SDA_S0
GND	11	12	+5V

2.5 Installing Din Rail Mounting (NUC-TGU)

Installing Din Rail Mounting

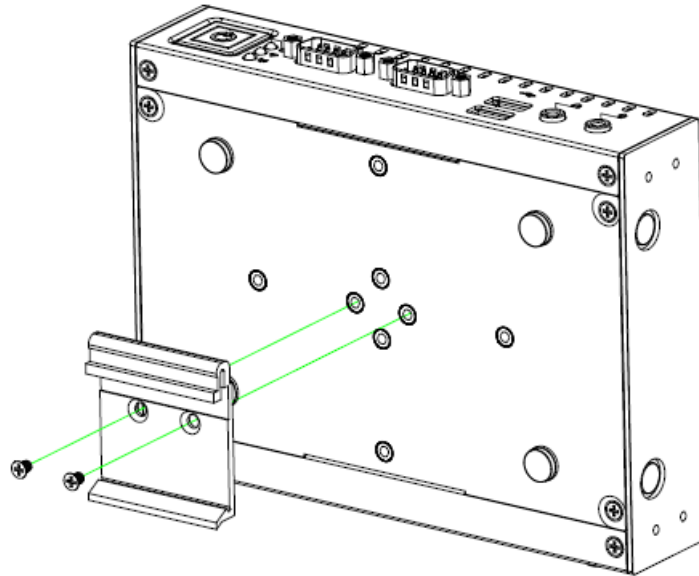

Step1. Fix with two M3*4 screws on the system.

2.6 Installing Stand Mounting (NUC-TGU)

Installing Stand Mounting

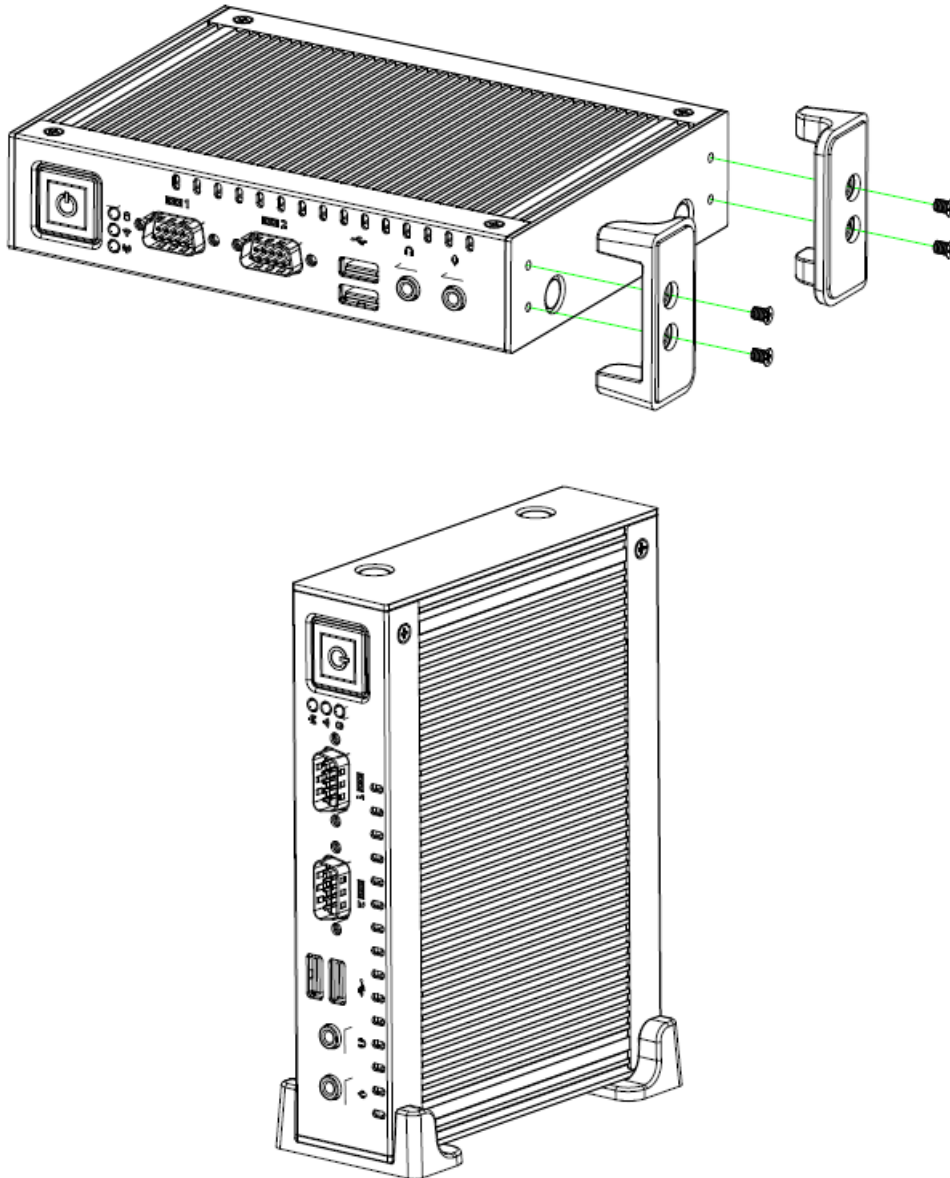

Step1. Fix with four 6#32*5 screws on the system.

2.7 Installing VESA Mounting (NUC-TGU)

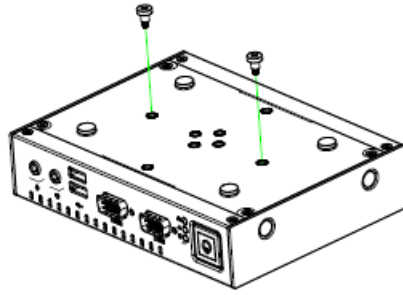

Step1. Insert and fasten two M3*L11.1 screw on the bottom.

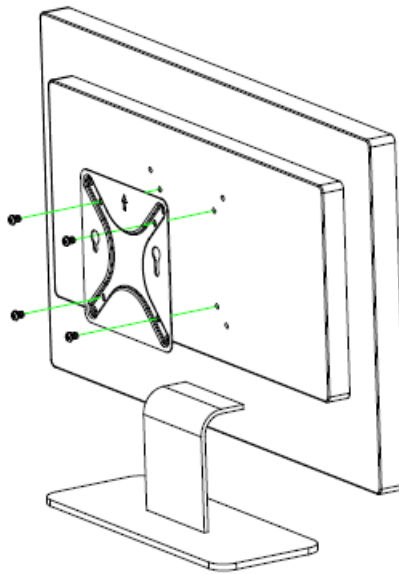

Step2. Fix with four M4*6mm screws on the monitor (or wall).

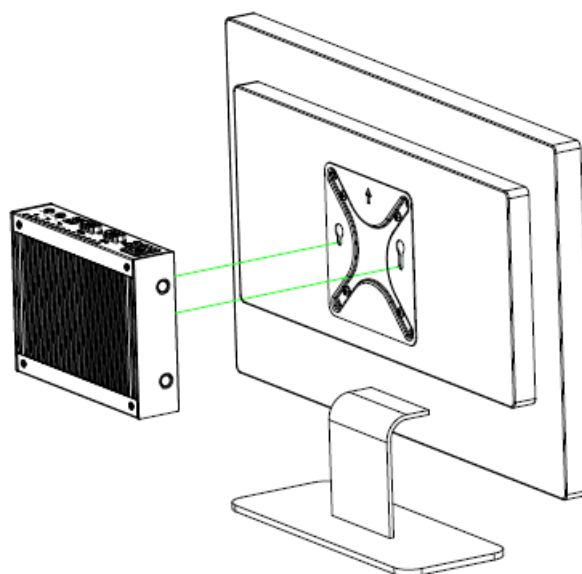

Step3. Slide the system onto the VESA mount bracket.

2.8 Installing Memory & M.2 card (NUC-TGU)

Step 1. Remove 4 screws from the bottom of your system and take it off.

Step 2. Slide the DDR4 SODIMM into the memory socket and press it down until properly seated.

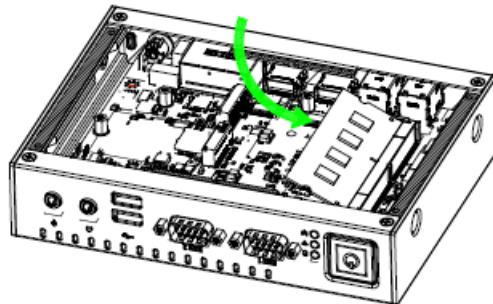
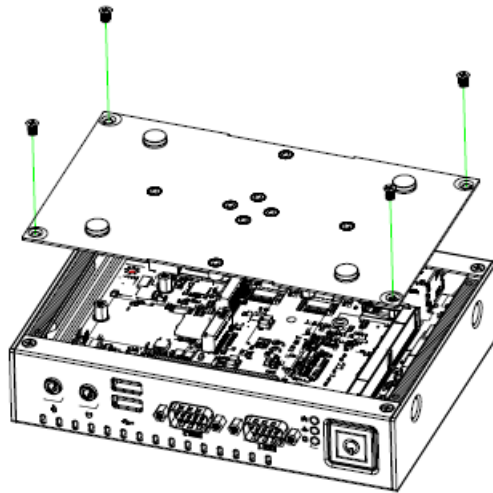

Step 3. Fix bracket (16.6*22) and standoff screw with M3.4 screw.

Step 4. Insert M.2 B-Key (2242)/(3042) card into designated locations and fasten with M2*3 screw to complete installation.

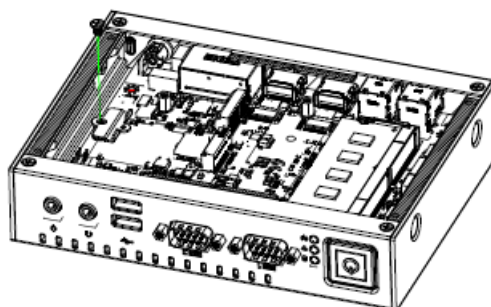

Installing M.2 Key E (2232) card

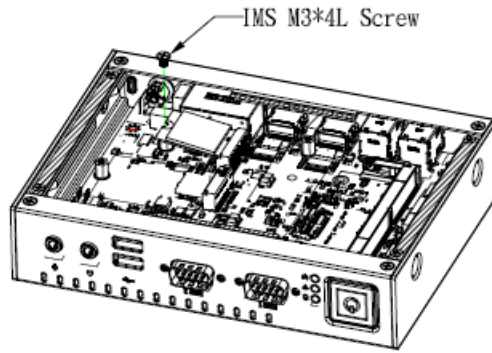

Installing M.2 Key M (2280) card

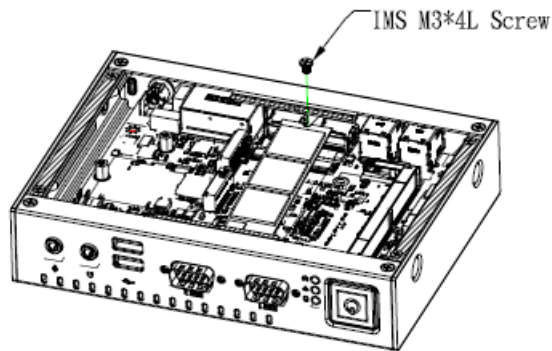

Installing M.2 B-Key (2242)/(3042)/(3052) card

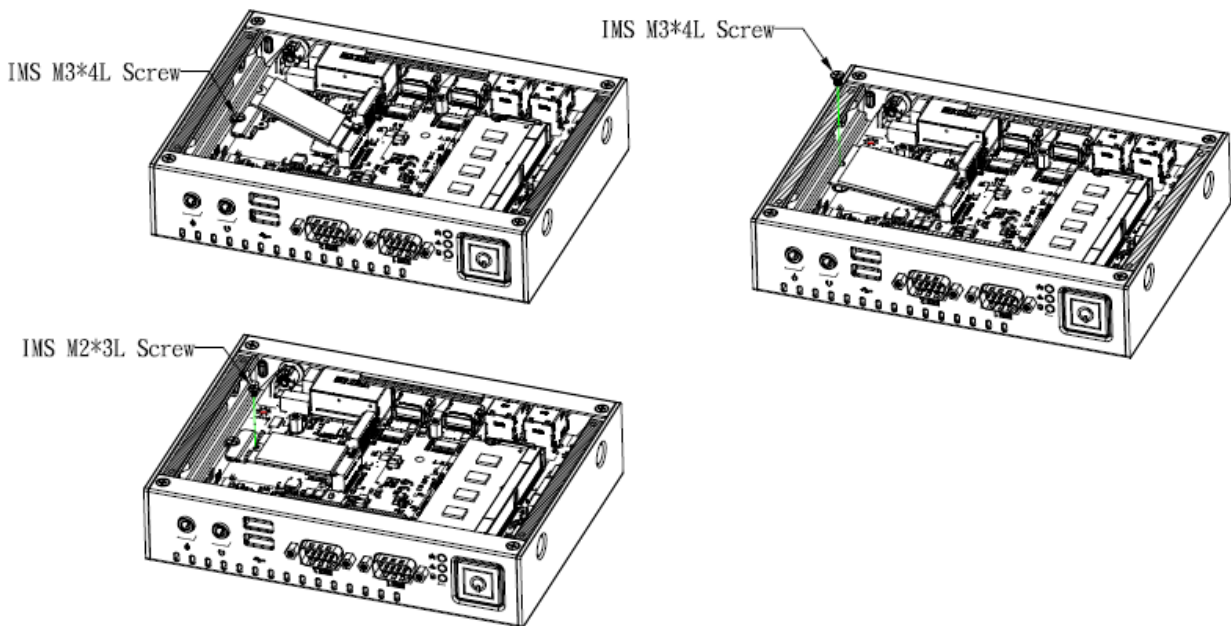

3. BIOS Setup

3.1 Introduction

The BIOS setup program allows users to modify the basic system configuration. In this following chapter will describe how to access the BIOS setup program and the configuration options that may be changed.

3.2 Starting Setup

AMI BIOS™ is immediately activated when you first power on the computer. The BIOS reads the system information contained in the NVRAM and begins the process of checking out the system and configuring it. When it finishes, the BIOS will seek an operating system on one of the disks and then launch and turn control over to the operating system.

While the BIOS is in control, the Setup program can be activated in one of two ways:

By pressing <ESC> or immediately after switching the system on, or

By pressing the <ESC> or key when the following message appears briefly at the left-top of the screen during the POST (Power On Self Test).

Press <ESC> or to enter SETUP

If the message disappears before you respond and you still wish to enter Setup, restart the system to try again by turning it OFF then ON or pressing the "RESET" button on the system case. You may also restart by simultaneously pressing <Ctrl>, <Alt>, and <Delete> keys.

3.3 Using Setup

In general, you use the arrow keys to highlight items, press <Enter> to select, use the PageUp and PageDown keys to change entries, press <F1> for help and press <Esc> to quit. The following table provides more detail about how to navigate in the Setup program using the keyboard.

Button	Description
↑	Move to previous item
↓	Move to next item
←	Move to the item in the left hand
→	Move to the item in the right hand
Esc key	Main Menu -- Quit and not save changes into NVRAM Status Page Setup Menu and Option Page Setup Menu -- Exit current page and return to Main Menu
+ key	Increase the numeric value or make changes
- key	Decrease the numeric value or make changes
F1 key	General help, only for Status Page Setup Menu and Option Page Setup Menu
F2 key	Previous Values
F3 key	Optimized defaults
F4 key	Save & Exit Setup

- **Navigating Through The Menu Bar**

Use the left and right arrow keys to choose the menu you want to be in.



Note: Some of the navigation keys differ from one screen to another.

- **To Display a Sub Menu**

Use the arrow keys to move the cursor to the sub menu you want. Then press <Enter>. A “➤” pointer marks all sub menus.

3.4 Getting Help

Press F1 to pop up a small help window that describes the appropriate keys to use and the possible selections for the highlighted item. To exit the Help Window press <Esc> or the <Enter> key again.

3.5 In Case of Problems

If, after making and saving system changes with Setup, you discover that your computer no longer is able to boot, the AMI BIOS supports an override to the NVRAM settings which resets your system to its defaults.

The best advice is to only alter settings which you thoroughly understand. To this end, we strongly recommend that you avoid making any changes to the chipset defaults. These defaults have been carefully chosen by both BIOS Vendor and your systems manufacturer to provide the absolute maximum performance and reliability. Even a seemingly small change to the chipset setup has the potential for causing you to use the override.

3.6 BIOS setup

Once you enter the Aptio Setup Utility, the Main Menu will appear on the screen. The Main Menu allows you to select from several setup functions and exit choices. Use the arrow keys to select among the items and press <Enter> to accept and enter the sub-menu.

3.6.1 Main Menu

This section allows you to record some basic hardware configurations in your computer and set the system clock.

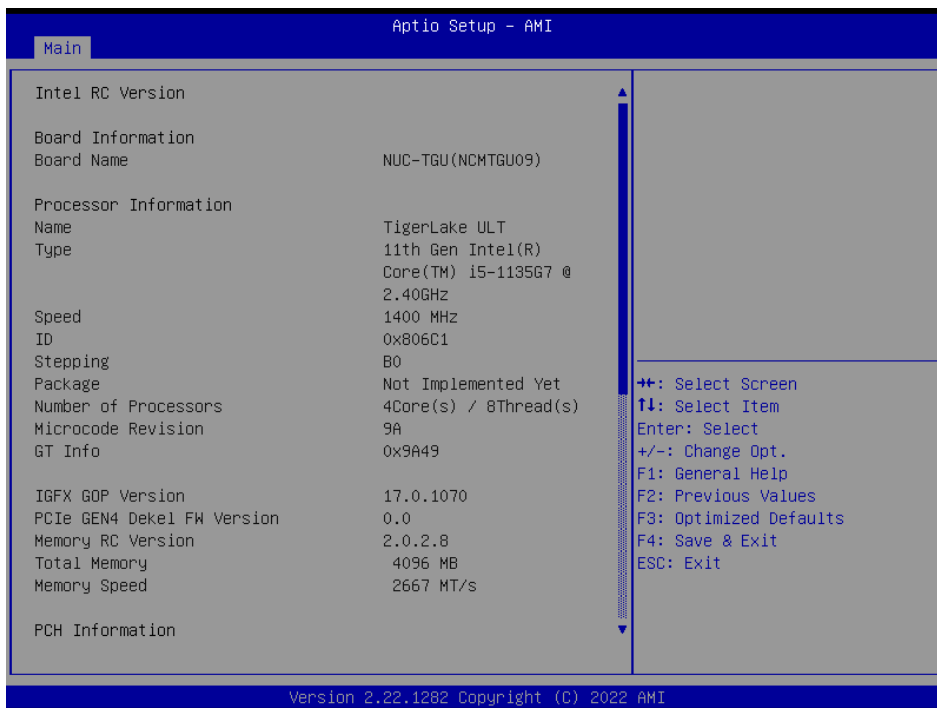

3.6.1.1 System Language

This option allows choosing the system default language.

3.6.1.2 System Date

Use the system date option to set the system date. Manually enter the day, month and year.

3.6.1.3 System Time

Use the system time option to set the system time. Manually enter the hours, minutes and seconds.



Note: The BIOS setup screens shown in this chapter are for reference purposes only, and may not exactly match what you see on your screen.

3.6.2 Advanced Menu

This section allows you to configure your CPU and other system devices for basic operation through the following sub-menus.



NUC-TGU

3.6.2.1 Connectivity Configuration



Item	Options	Description
CNVi Mode	Disable Integrated Auto Detection[Default]	This option configures Connectivity. [Auto Detection] means that if Discrete solution is discovered it will be enabled by default. Otherwise Integrated solution (CNVi) will be enabled; [Disable Integrated] disables Integrated Solution. NOTE: When CNVi is present, the GPIO pins that are used for radio.

3.6.2.2 CPU Configuration

Use the CPU configuration menu to view detailed CPU specification and configure the CPU.

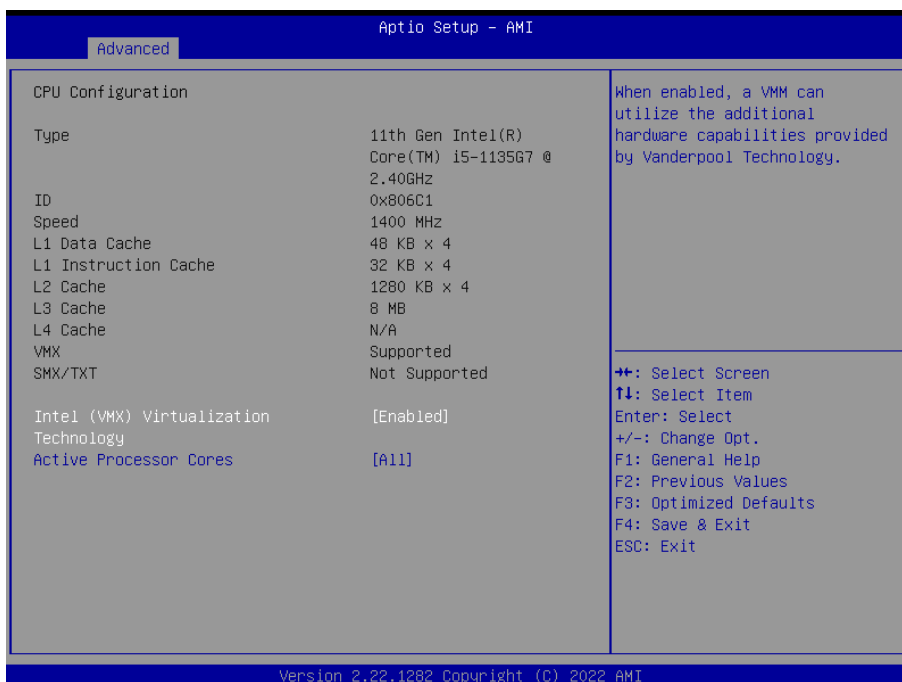

Item	Options	Description
Intel (VMX) Virtualization Technology	Disabled Enabled[Default]	When enabled, a VMM can utilize the additional hardware capabilities provided by Vanderpool Technology.
Active Processor Cores	All[Default] 1 2 3 4 5 6 7 8	Number of cores to enable in each processor package.

3.6.2.3 Power & Performance



3.6.2.3.1 CPU – Power Management Control

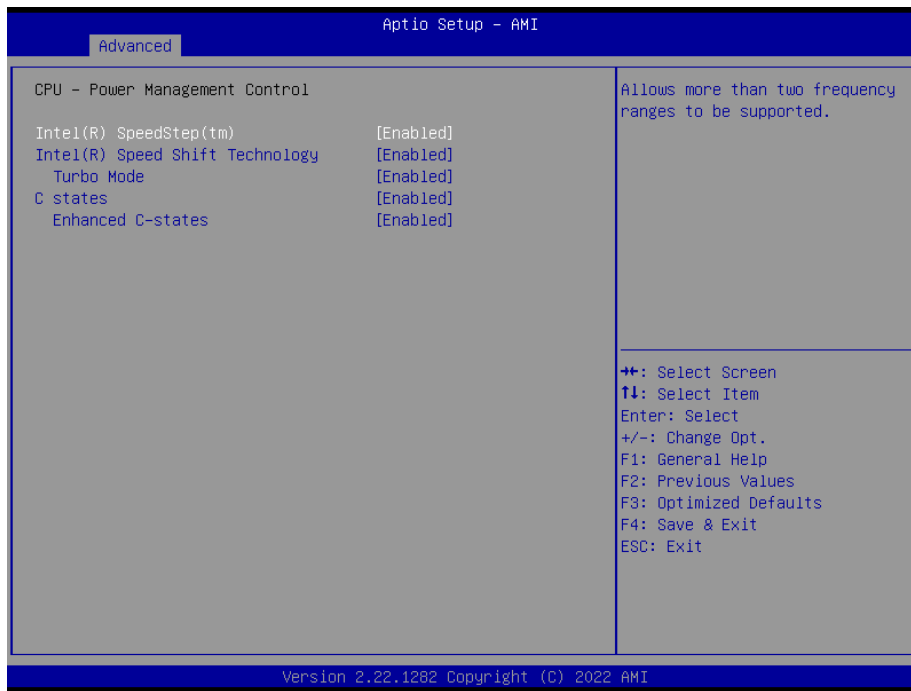

Item	Option	Description
Intel® SpeedStep™	Enabled[Default], Disabled	Allows more than two frequency ranges to be supported.
Intel® Speed Shift Technology	Enabled[Default], Disabled	Enable/Disable Intel® Speed Shift Technology support. Enabling will expose the CPPC v2 interface to allow for hardware controlled P-states.
Turbo Mode	Enabled[Default], Disabled	Enable/Disable processor Turbo Mode (requires Intel Speed Step or Intel Speed Shift to be available and enabled).
C States	Enabled[Default], Disabled	Enable/Disable CPU Power Management.
Enhanced C-States	Enabled[Default], Disabled	Enable/Disable C1E. When enabled, CPU will switch to minimum speed when all cores enter C-State.

3.6.2.4 PCH-FW Configuration

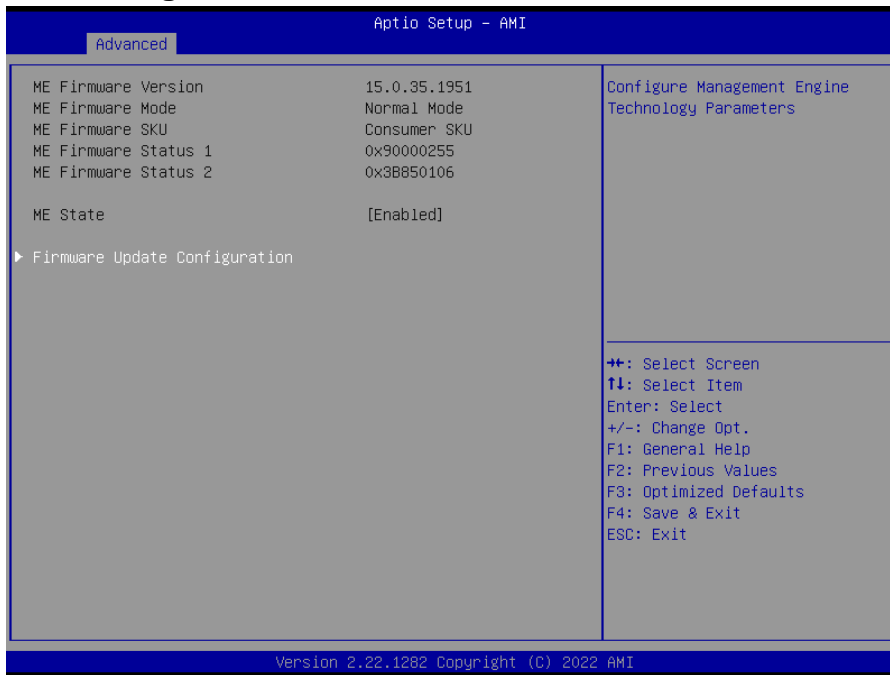

3.6.2.4.1 Firmware Update Configuration



Item	Option	Description
ME FW Image Re-Flash	Disabled[Default], Enabled	Enable/Disable Me FW Image Re-Flash function.

3.6.2.5 Trusted Computing



Item	Options	Description
Security Device Support	Disable, Enable [Default]	Enables or Disables BIOS support for security device. O.S. will not show Security Device. TCG EFI protocol and INT1A interface will not be available.

3.6.2.6 ACPI Settings



Item	Options	Description
Enable Hibernation	Disabled Enabled[Default],	Enables or Disables System ability to Hibernate (OS/S4 Sleep State). This option may not be effective with some OS.
ACPI Sleep State	Suspend Disabled, S3 (Suspend to RAM)[Default]	Select the highest ACPI sleep state the system will enter when the SUSPEND button is pressed.

3.6.2.7 Super IO Configuration

You can use this item to set up or change the Super IO configuration for serial ports. Please refer to 3.6.2.7.1 ~ 3.6.2.7.2 for more information.

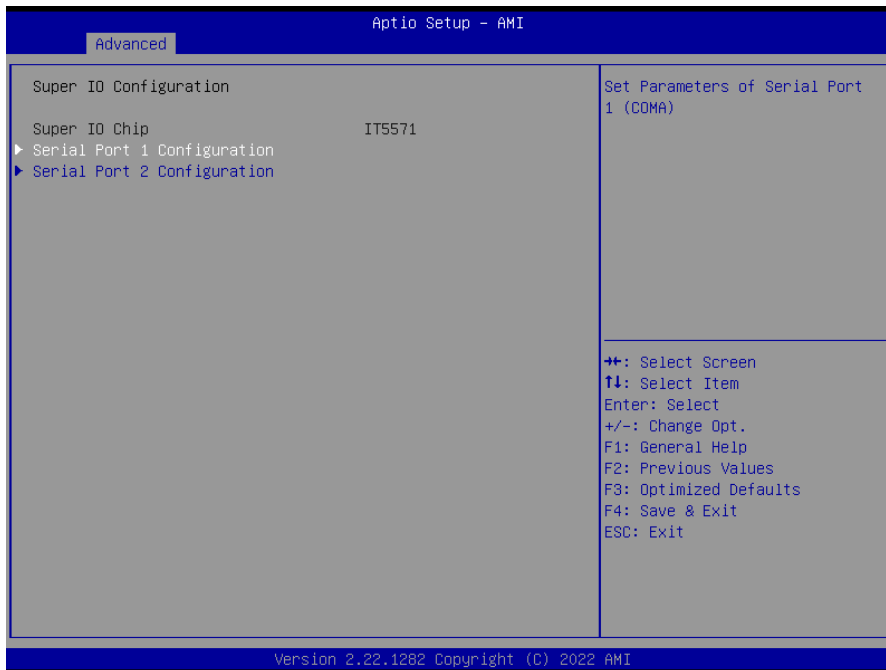

Item	Description
Serial Port 1 Configuration	Set Parameters of Serial Port 1 (COMA).
Serial Port 2 Configuration	Set Parameters of Serial Port 2 (COMB).

3.6.2.7.1 Serial Port 1 Configuration

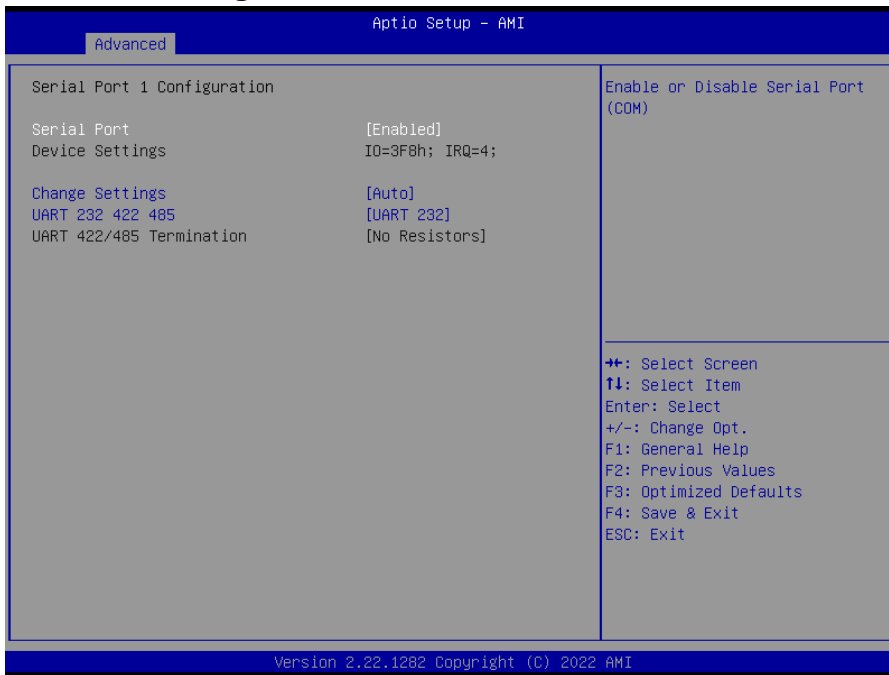

Item	Option	Description
Serial Port	Enabled[Default], Disabled	Enable or Disable Serial Port (COM).
Change Settings	Auto[Default], IO=3F8h; IRQ=4, IO=3F8h; IRQ=3,4,5,6,7,9,10,11,12 IO=2F8h; IRQ=3,4,5,6,7,9,10,11,12 IO=3E8h; IRQ=3,4,5,6,7,9,10,11,12 IO=2E8h; IRQ=3,4,5,6,7,9,10,11,12	Select an optimal settings for Super IO Device.
UART 232 422 485	UART 232[Default] UART 422 UART 485	Change the Serial Port as RS232/422/485.

3.6.2.7.2 Serial Port 2 Configuration

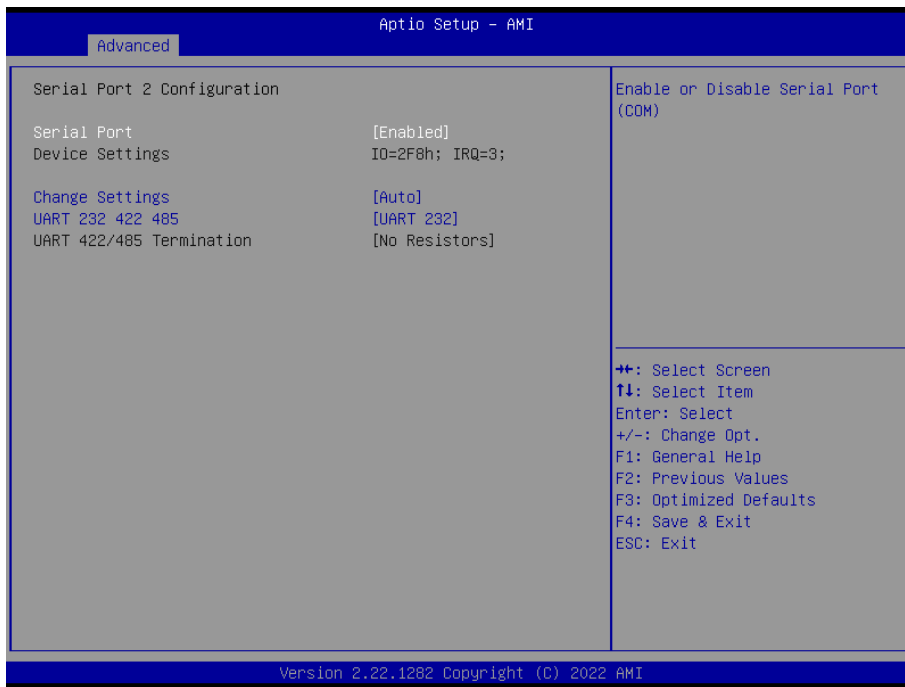

Item	Option	Description
Serial Port	Enabled[Default], Disabled	Enable or Disable Serial Port (COM).
Change Settings	Auto[Default], IO=2F8h; IRQ=3, IO=3F8h; IRQ=3,4,5,6,7,9,10,11,12 IO=2F8h; IRQ=3,4,5,6,7,9,10,11,12 IO=3E8h; IRQ=3,4,5,6,7,9,10,11,12 IO=2E8h; IRQ=3,4,5,6,7,9,10,11,12	Select an optimal settings for Super IO Device.
UART 232 422 485	UART 232[Default] UART 422 UART 485	Change the Serial Port as RS232/422/485.

3.6.2.8 HW Monitor

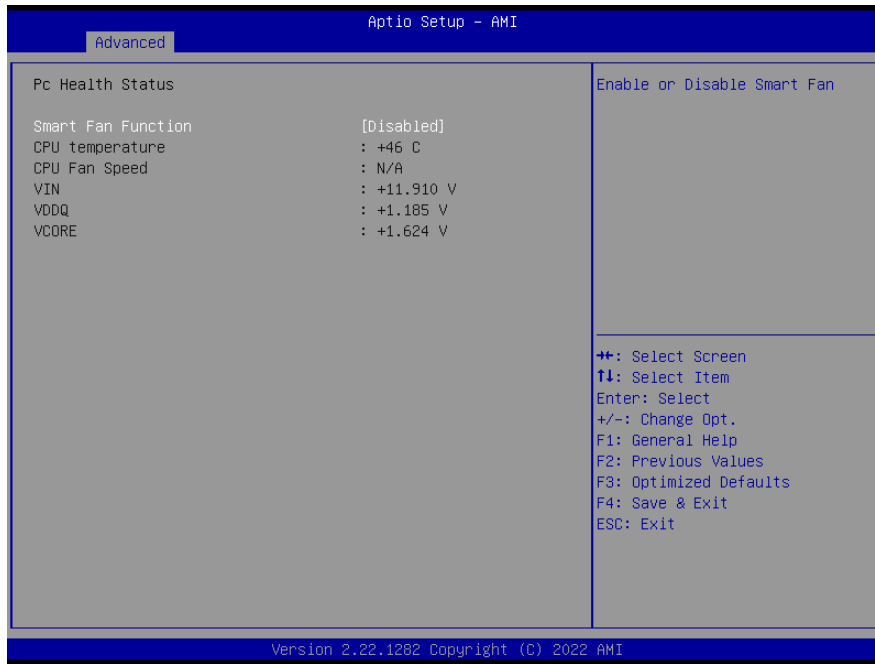

Item	Options	Description
Smart Fan Function	Enabled, Disabled[Default]	Enables or Disables Smart Fan.

3.6.2.9 S5 RTC Wake Settings



Item	Options	Description
Wake system from S5	Disabled[Default], Fixed Time Dynamic Time	Enable or disable System wake on alarm event. Select Fixed Time, system will wake on the hr::min::sec specified. Select Dynamic Time, System will wake on the current time + Increase minute(s).

3.6.2.10 USB Configuration

The USB Configuration menu helps read USB information and configures USB settings.



Item	Options	Description
USB transfer time-out	1 sec 5 sec 10 sec 20 sec [Default]	The time-out value for Control, Bulk, and Interrupt transfers.
Device reset time-out	10 sec 20 sec [Default] 30 sec 40 sec	USB mass storage device Start Unit command time-out.
Device power-up delay	Auto [Default] Manual	Maximum time the device will take before it properly reports itself to the Host Controller. 'Auto' uses default value: for a Root port it is 100ms, for a Hub port the delay is taken from Hub descriptor.
Mass Storage Devices	Auto [Default] Floppy Forced FDD Hard Disk CD-ROM	Mass storage device emulation type. 'AUTO' enumerates devices according to their media format. Optical drives are emulated as 'CDROM', drives with no media will be emulated according to a drive type.

3.6.2.11 Network Stack Configuration

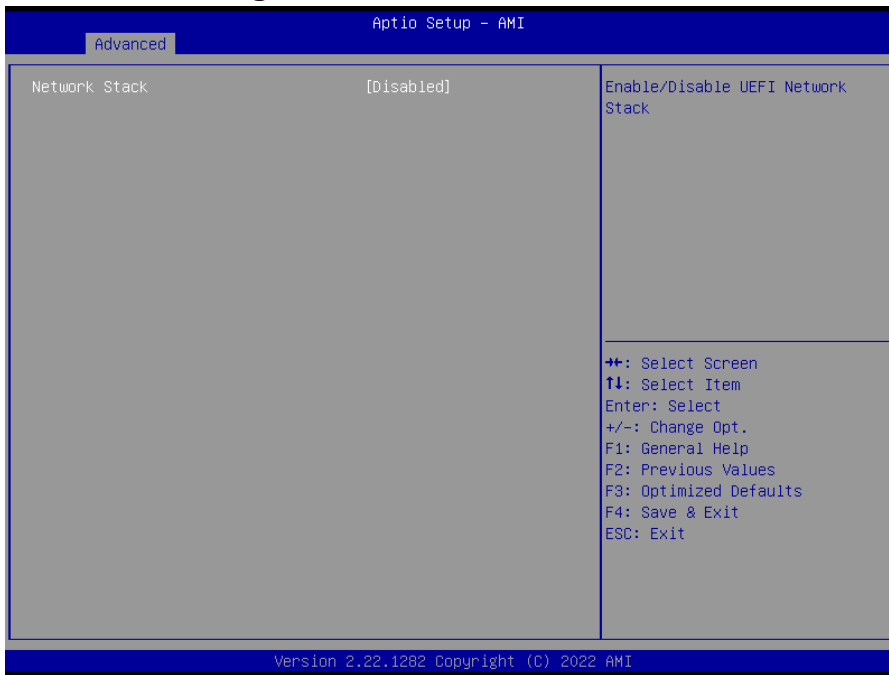

Item	Options	Description
Network Stack	Enabled Disabled[Default]	Enable/Disable UEFI Network Stack.

3.6.2.12 NVMe Configuration



3.6.3 Chipset

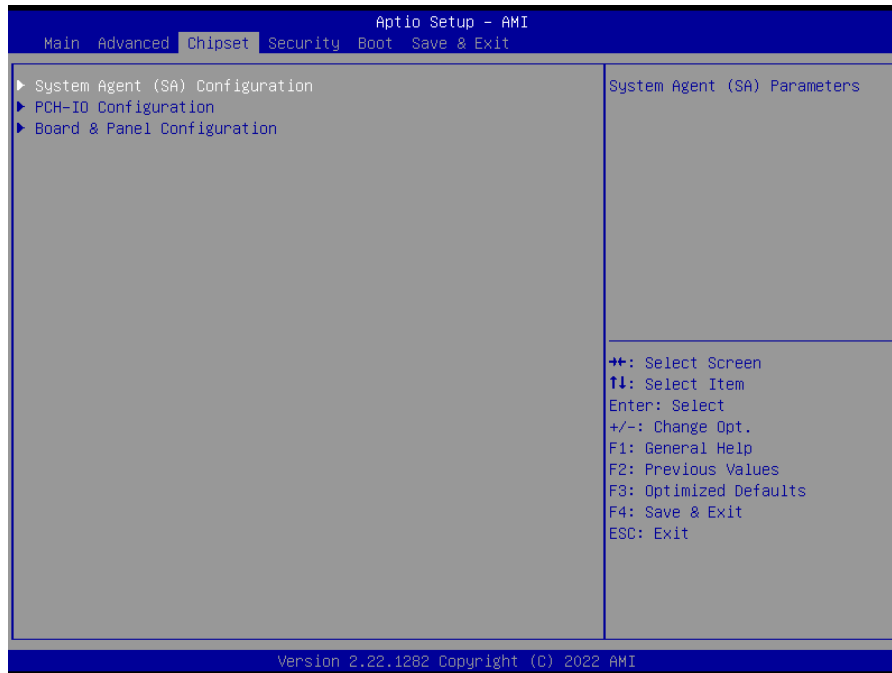

3.6.3.1 System Agent (SA) Configuration



Item	Option	Description
VT-d	Enabled[Default] Disabled	VT-d capability.

3.6.3.1.1 Memory Configuration

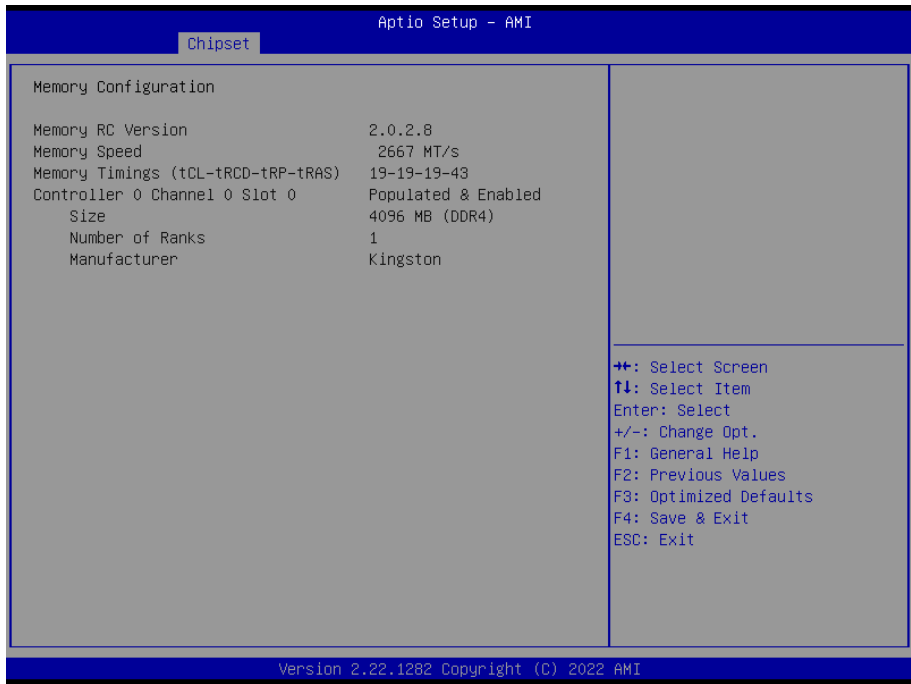

3.6.3.1.2 Graphics Configuration

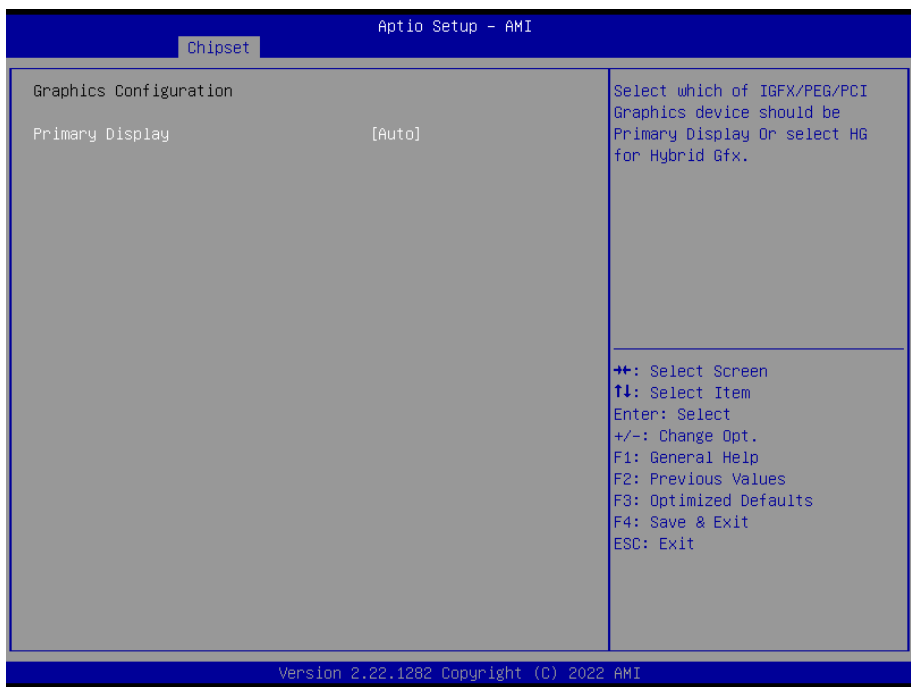

Item	Option	Description
Primary Display	Auto[Default]	Select which of IGFX/PEG/PCI Graphics device should be Primary Display Or select SG for Switchable Gfx.
	IGFX	
	PEG	
	PCI	
	SG	

3.6.3.1.3 VMD setup menu

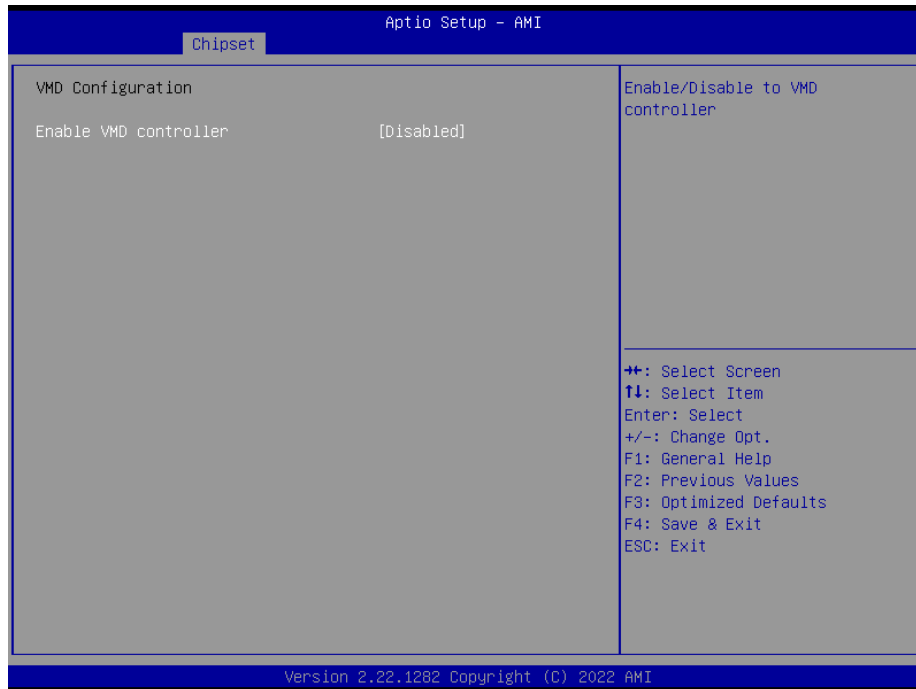

Item	Option	Description
Enable VMD controller	Enabled Disabled[Default]	Enable/Disable VMD controller.

3.6.3.2 PCH-IO Configuration



Item	Option	Description
PCH LAN Controller	Enabled[Default], Disabled	Enable/Disable onboard NIC.

3.6.3.2.1 PCI Express Configuration

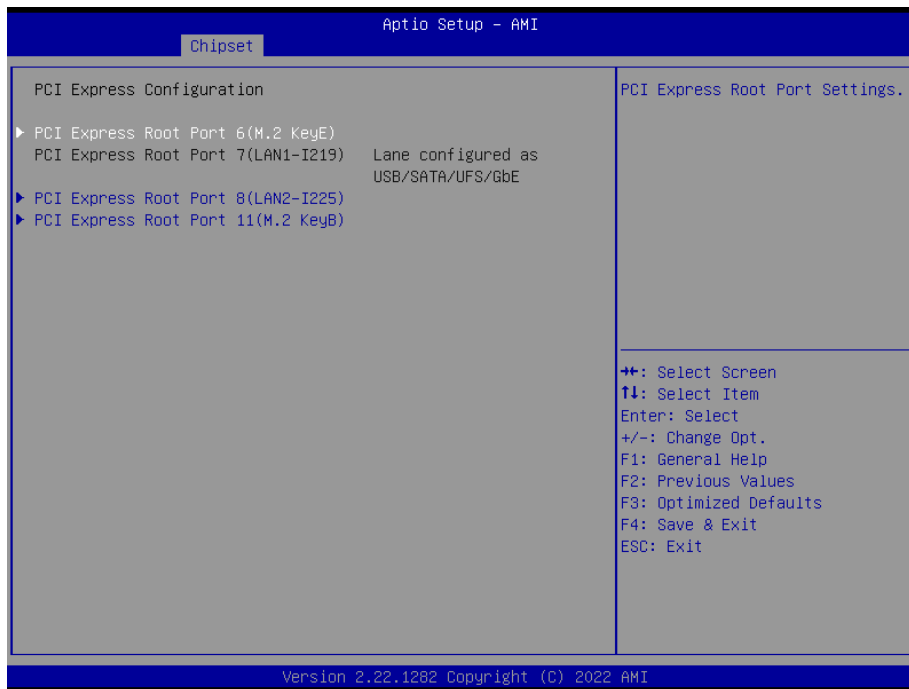

3.6.3.2.1.1 PCI Express Root Port 6(M.2 KeyE)



Item	Option	Description
PCI Express Root Port 6(M.2 KeyE)	Enabled[Default], Disabled	Control the PCI Express Root Port.
ASPM	Disabled[Default], L0s	Set the ASPM Level: Force L0s – Force all links to L0s State AUTO – BIOS auto

	L1 L0sL1 Auto	configure DISABLE – Disables ASPM.
L1 Substates	Disabled, L1.1 L1.1 & L1.2[Default]	PCI Express L1 Substates settings.
PCIe Speed	Auto[Default] Gen1 Gen2 Gen3	Configure PCIe Speed.

3.6.3.2.1.2 PCI Express Root Port 8(LAN2-I225)

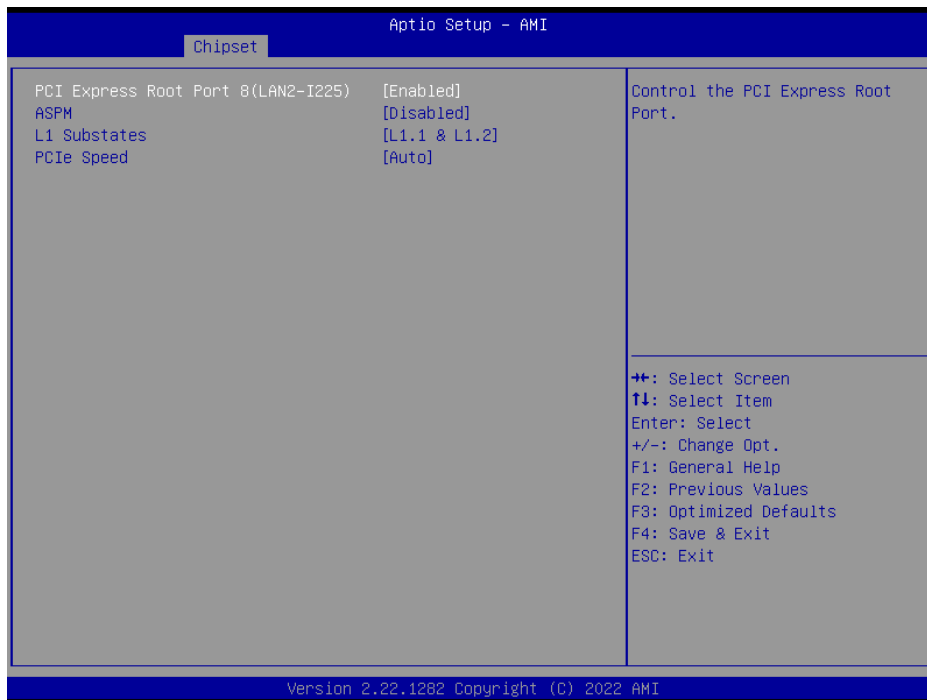

Item	Option	Description
PCI Express Root Port 8(LAN2-I225)	Enabled[Default], Disabled	Control the PCI Express Root Port.
ASPM	Disabled[Default], L0s L1 L0sL1 Auto	Set the ASPM Level: Force L0s – Force all links to L0s State AUTO – BIOS auto configure DISABLE – Disables ASPM.
L1 Substates	Disabled, L1.1 L1.1 & L1.2[Default]	PCI Express L1 Substates settings.
PCIe Speed	Auto[Default] Gen1 Gen2 Gen3	Configure PCIe Speed.

3.6.3.2.1.3 PCI Express Root Port 11(M.2 KeyB)



Item	Option	Description
PCI Express Root Port 11(M.2 KeyB)	Enabled[Default], Disabled	Control the PCI Express Root Port.
ASPM	Disabled[Default], L0s L1 L0sL1 Auto	Set the ASPM Level: Force L0s – Force all links to L0s State AUTO – BIOS auto configure DISABLE – Disables ASPM.
L1 Substates	Disabled, L1.1 L1.1 & L1.2[Default]	PCI Express L1 Substates settings.
PCIe Speed	Auto[Default] Gen1 Gen2 Gen3	Configure PCIe Speed.

3.6.3.2.2 SATA And RST Configuration

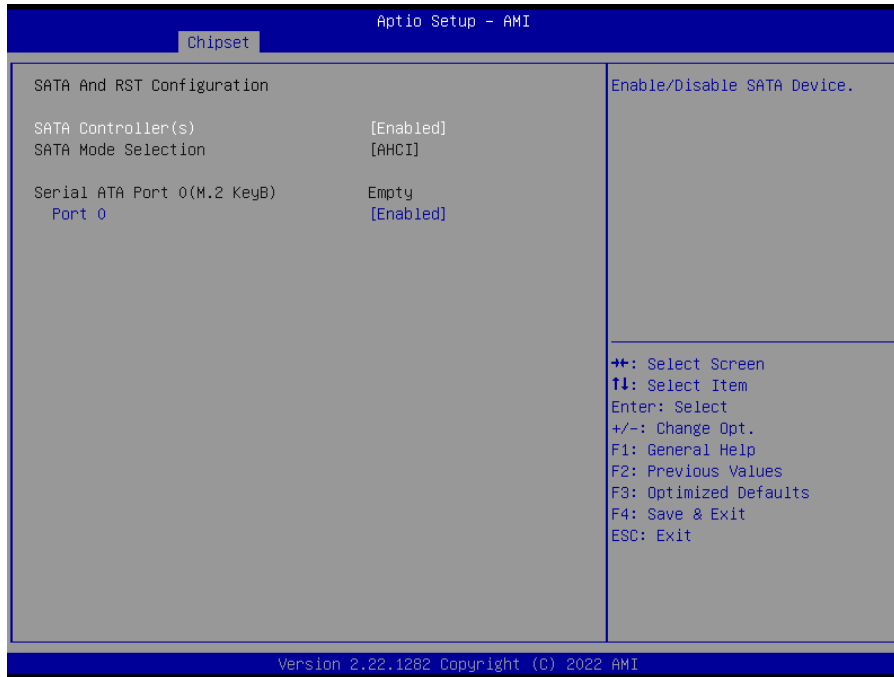

Item	Options	Description
SATA Controller(s)	Enabled[Default] Disabled,	Enable/Disable SATA Device.
Port 0	Enabled[Default] Disabled	Enable or Disable SATA Port.

3.6.3.2.3 HD Audio Configuration



NUC-TGU

Item	Option	Description
HD Audio	Disabled Enabled[Default]	Control Detection of the HD-Audio device. Disable = HDA will be unconditionally disabled Enabled = HDA will be unconditionally enabled.

3.6.3.3 Board & Panel Configuration

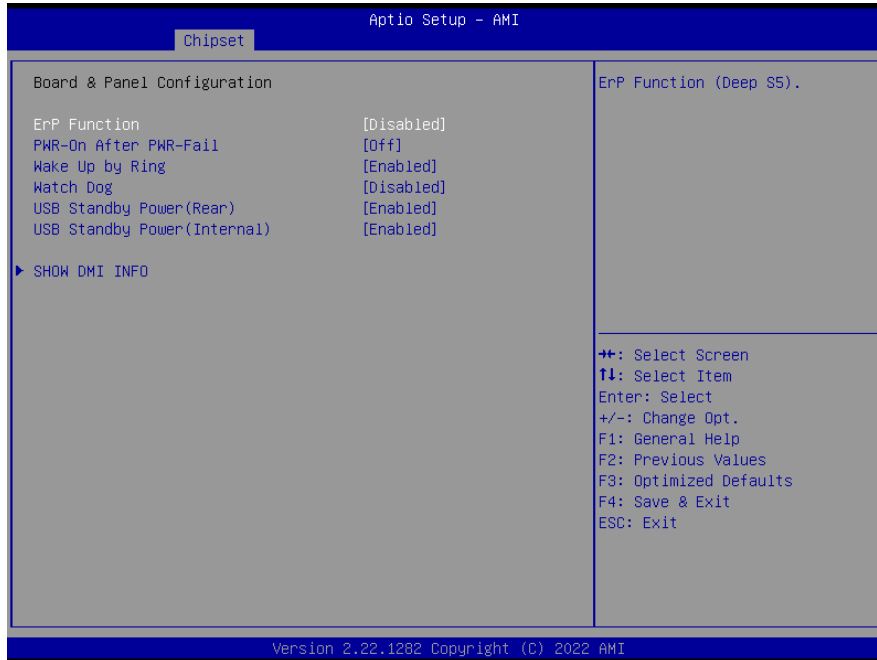

Item	Option	Description
ErP Function	Disabled[Default] Enabled	ErP Function (Deep S5).
PWR-On After PWR-Fail	Off[Default] On Last state	AC loss resume.
Wake Up by Ring	Disabled Enabled[Default]	Wake Up by Ring from S3/S4/S5.
Watch Dog	Disabled[Default] 30 sec 40 sec 50 sec 1 min 2 min 10 min 30 min	Select WatchDog.
USB Standby Power(Rear)	Disabled Enabled[Default]	Enable/Disabled USB Standby Power during S3/S4/S5.
USB Standby Power(Internal)	Disabled Enabled[Default]	Enable/Disabled USB Standby Power during S3/S4/S5.

3.6.3.3.1 SHOW DMI INFO

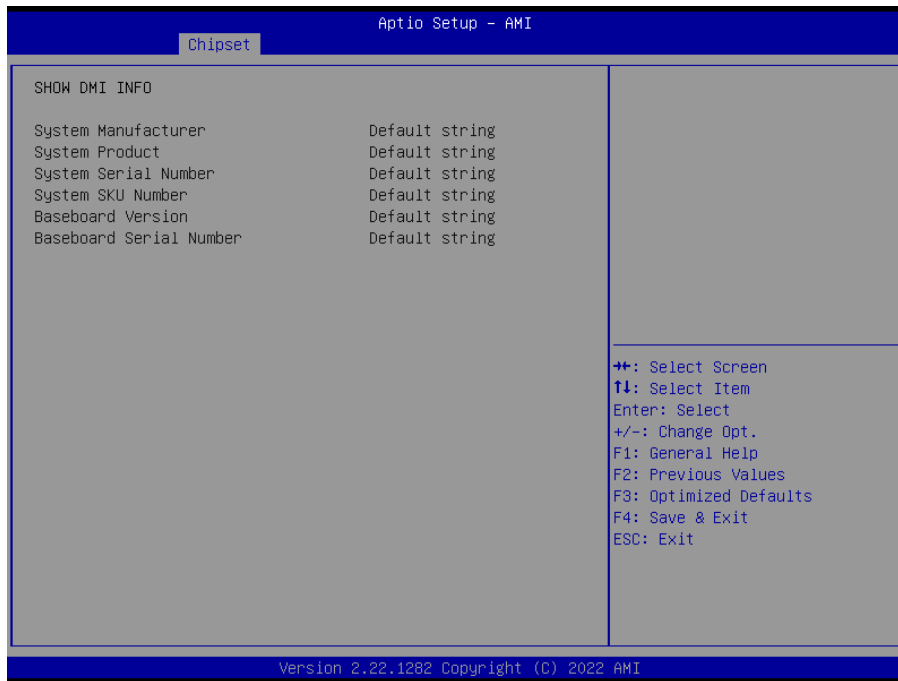

3.6.4 Security

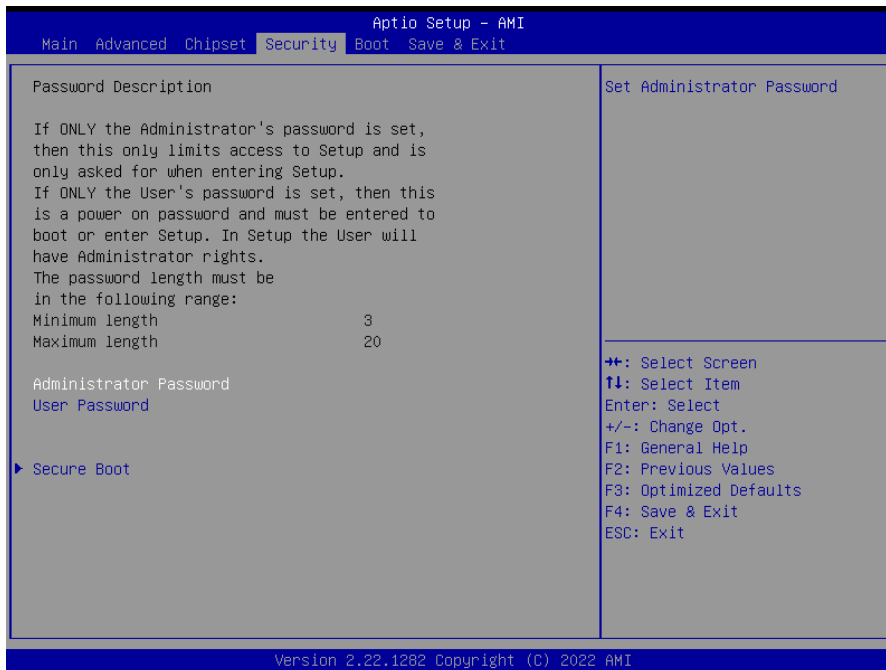

- **Administrator Password**

Set setup Administrator Password

- **User Password**

Set User Password

3.6.4.1 Secure Boot

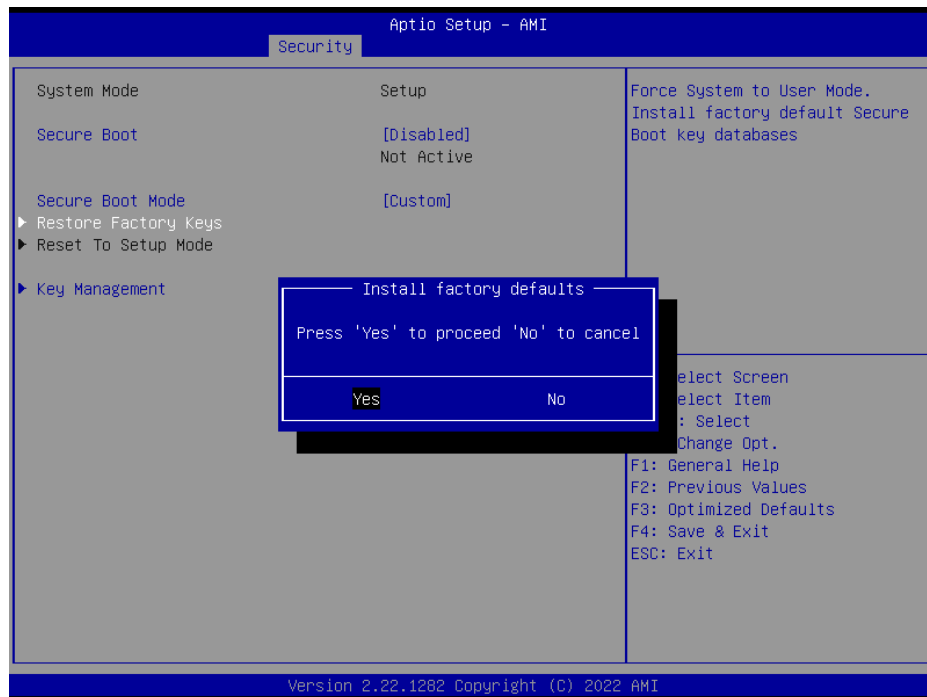

Item	Option	Description
Secure Boot	Disabled[Default] Enabled	Secure Boot feature is Active if Secure Boot is Enable, Platform Key(PK) is enrolled and the System is in User mode. The mode change requires platform reset.
Secure Boot Mode	Standard Custom[Default]	Secure Boot mode selector: Standard/Custom. In Custom mode Secure Boot Variables can be configured without authentication.

3.6.4.1.1 Key Management

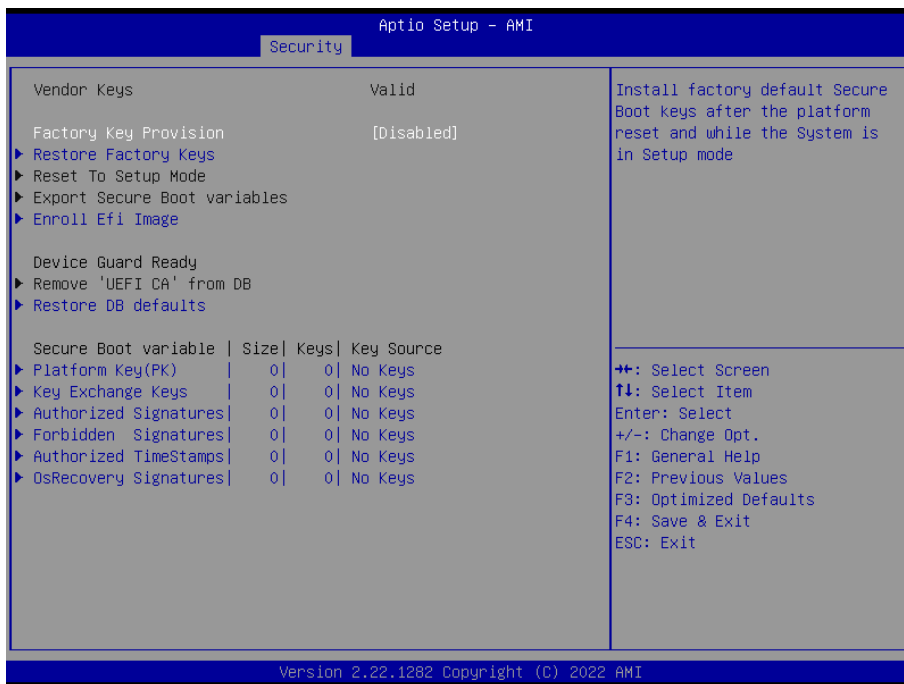

Item	Option	Description
Factory Key Provision	Disabled[Default] Enabled	Install factory default Secure Boot keys after the platform reset and while the System is in Setup mode.

3.6.5 Boot

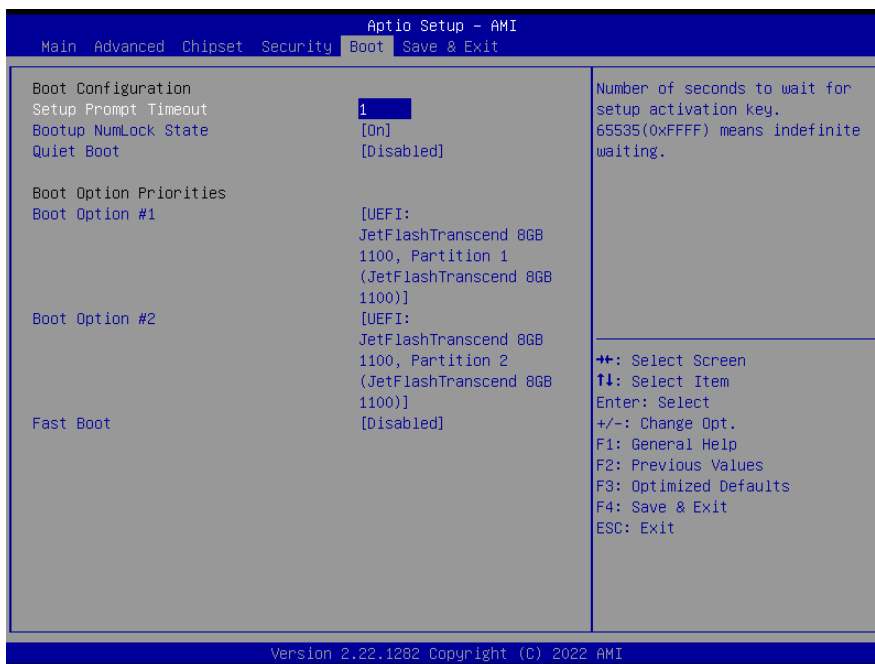

NUC-TGU

Item	Option	Description
Setup Prompt Timeout	1~ 65535	Number of seconds to wait for setup activation key. 65535(0xFFFF) means indefinite waiting.
Bootup NumLock State	On[Default] Off	Select the keyboard NumLock state
Quiet Boot	Disabled[Default] Enabled	Enables or disables Quiet Boot option
Fast Boot	Disabled[Default] Enabled	Enables or disables boot with initialization of a minimal set of devices required to launch active boot option. Has no effect for BBS boot options.
Boot Option #1/2	Set the system boot order.	

3.6.6 Save and exit

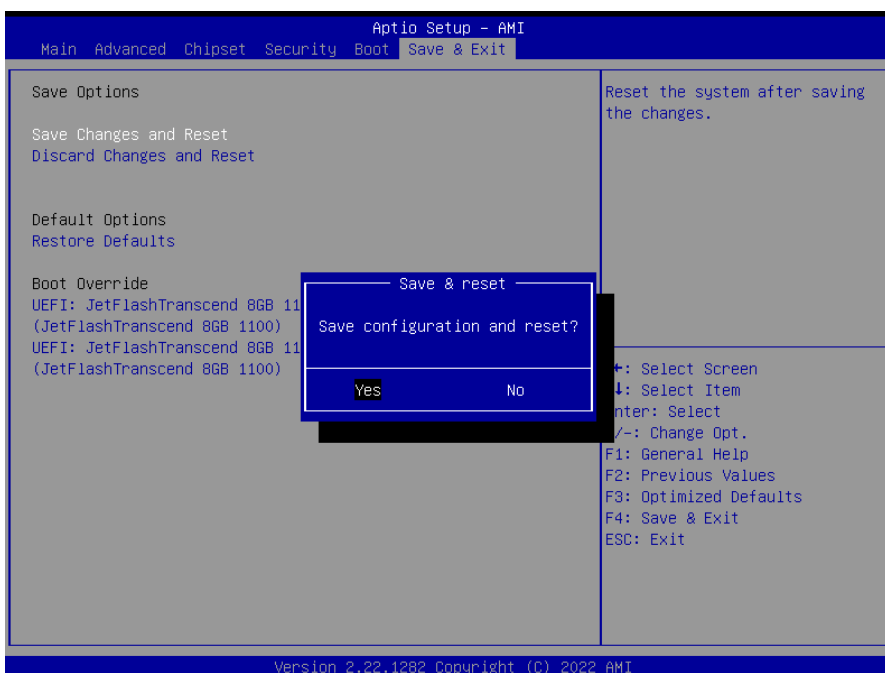
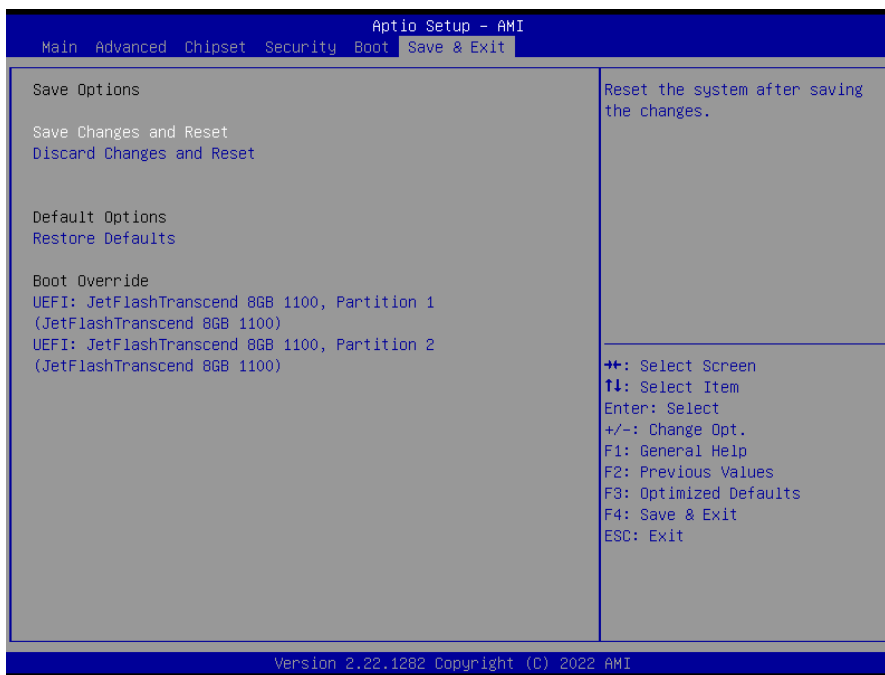

3.6.6.1 Save Changes and Reset

Reset the system after saving the changes.

3.6.6.2 Discard Changes and Reset

Any changes made to BIOS settings during this session of the BIOS setup program are discarded. The setup program then exits and reboots the controller.

3.6.6.3 Restore Defaults

This option restores all BIOS settings to the factory default. This option is useful if the controller exhibits unpredictable behavior due to an incorrect or inappropriate BIOS setting.

3.6.6.4 Launch EFI Shell from filesystem device

Attempts to Launch EFI Shell application (Shellx64.efi) from one of the available filesystem devices.

4. Drivers Installation



Note: Installation procedures and screen shots in this section are for your reference and may not be exactly the same as shown on your screen.

4.1 Install Chipset Driver



Note: The installation procedures and screen shots in this section are based on Windows 10 operation system. If the warning message appears while the installation process, click Continue to go on.



Step 3. Click Install.



Step1. Click Next.



Step 4. Setup completed.



Step 2. Click Accept.

4.2 Install VGA Driver



Note: The installation procedures and screen shots in this section are based on Windows 10 operation system.

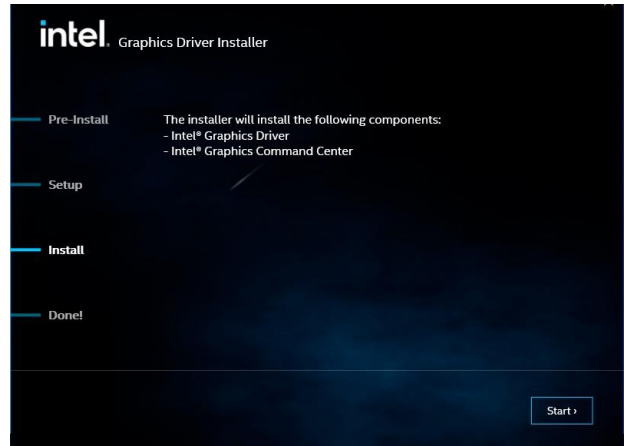

Step 3. Click Start.



Step 1. Click Begin installation.

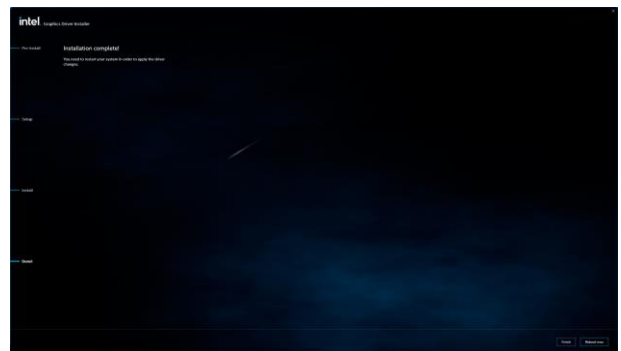

Step 4. Click Finish to complete setup.

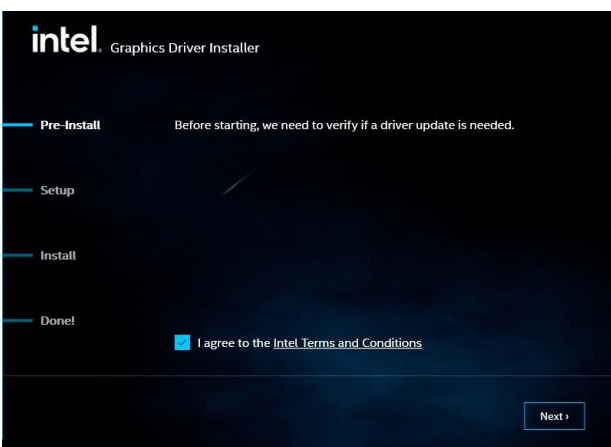

Step 2.
Click **Next** to accept license agreement.

4.3 Install LAN Driver



Note: The installation procedures and screen shots in this section are based on Windows 10 operation system. If the warning message appears while the installation process, click Continue to go on.

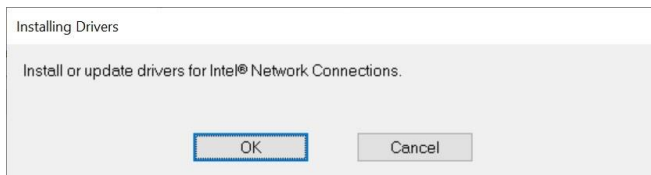

Step1. Click **OK** to Install.



Step 2. Setup completed.

4.4 Install Serial IO Driver



Note: The installation procedures and screen shots in this section are based on Windows 10 operation system.

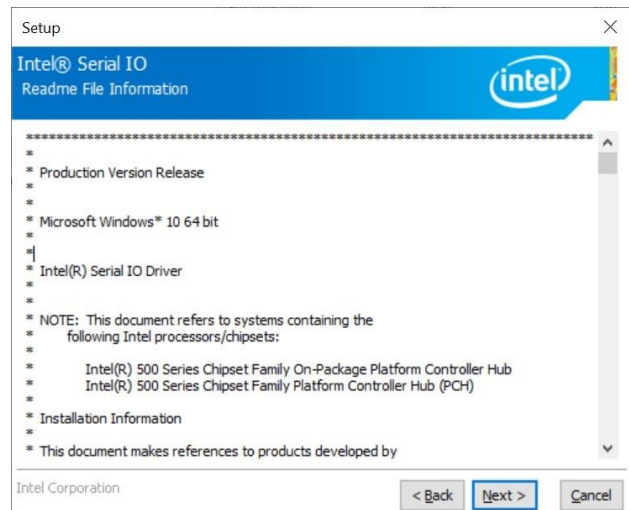

Step 3. Click Next.

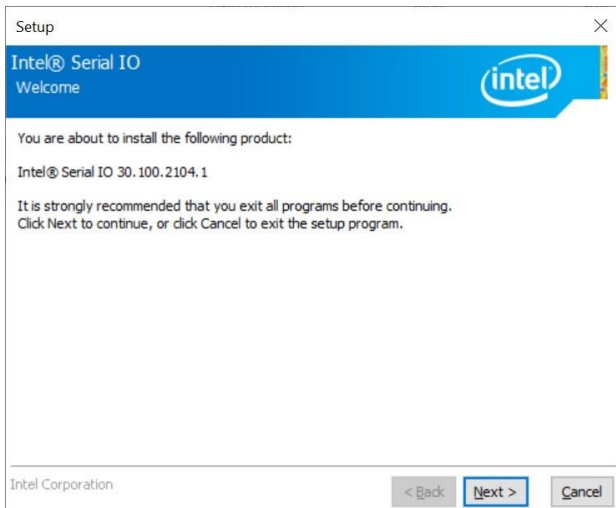

Step 1. Click Next to continue installation.

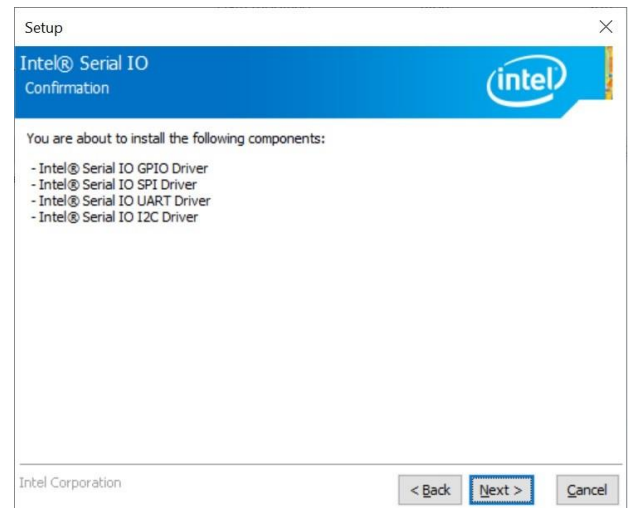

Step 4. Click Next.



Step 2. Click Next.



Step 5. Click Finish to complete setup.

4.5 Install Audio Driver



Note: The installation procedures and screen shots in this section are based on Windows 10 operation system.

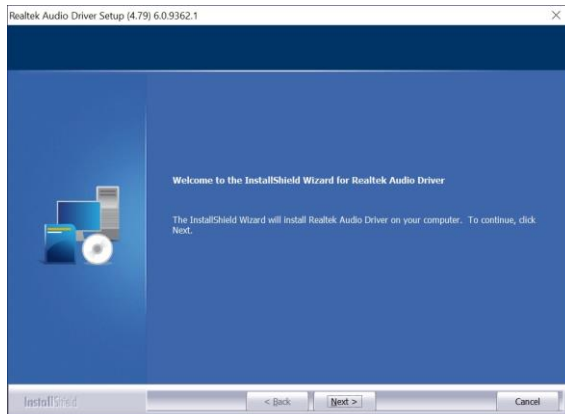

Step 1. Step1. Click **Next** to Install.

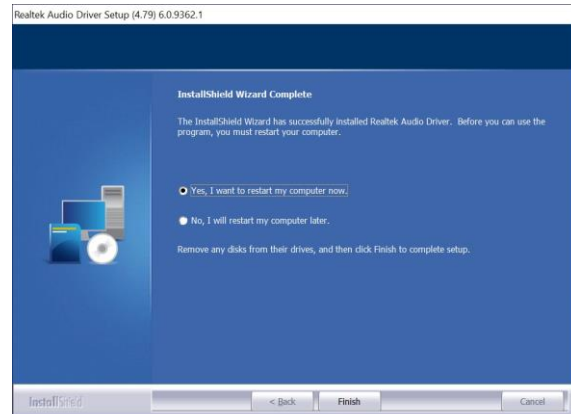

Step 2. Click **Finish** to complete setup.

4.6 Install ME Driver



Note: The installation procedures and screen shots in this section are based on Windows 10 operation system.

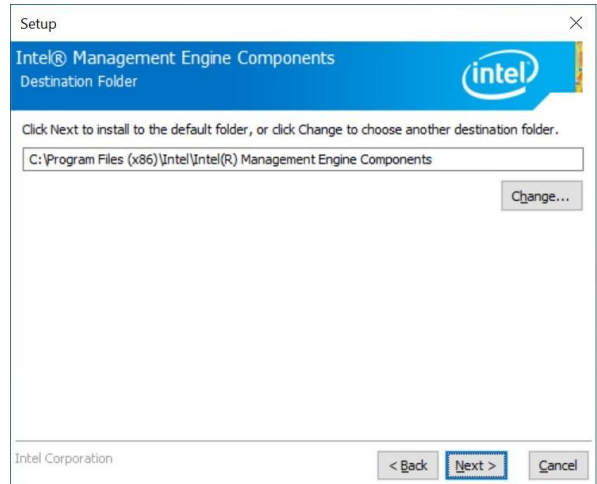

Step 3. Click Next

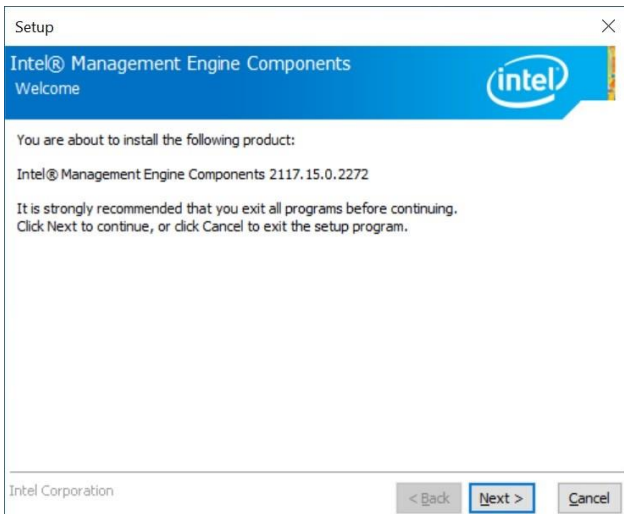

Step 1. Click Next to continue setup.

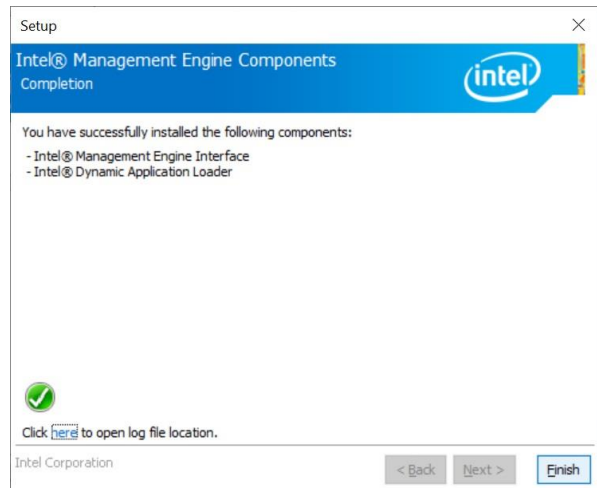

Step 4. Click Finish to complete the setup.



Step 2. Click Next.

4.7 Install Realtek Audio Control Driver



Note: The installation procedures and screen shots in this section are based on Windows 10 operation system.

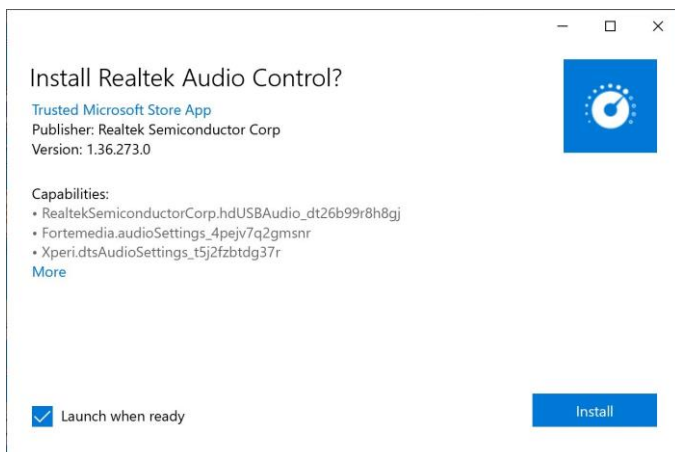

Step 1. Click Install.

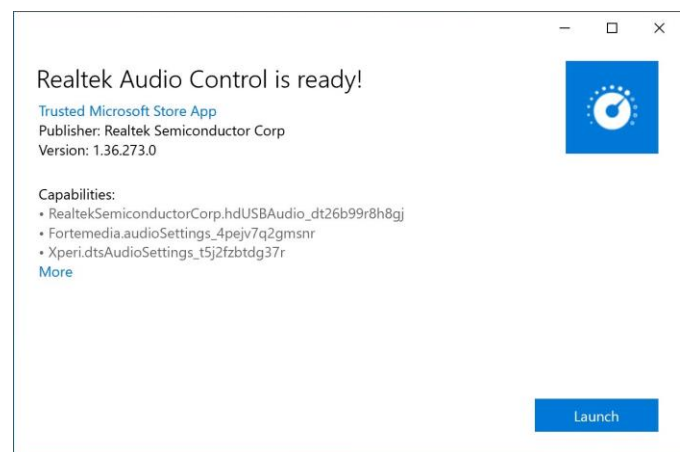

Step 2. Setup completed.